



# **CprE 281: Digital Logic**

**Instructor: Alexander Stoytchev**

**<http://www.ece.iastate.edu/~alexs/classes/>**

# State Minimization

*CprE 281: Digital Logic*  
*Iowa State University, Ames, IA*  
*Copyright © Alexander Stoytchev*

# **Administrative Stuff**

- **Final Project**
- **Posted on the class web page (Labs section)**
- **Pick one of the problems and solve it.**
- **Your grade will not depend on which project you pick**
- **By next Wednesday you need to select your project and send an e-mail to your lab TAs**

# Sample E-mail

**Hello TAs,**

**I decided to pick problem number x for my final project in CprE 281.**

**Thanks,**

**[your name]**



# Equivalence of states

“Two states  $S_i$  and  $S_j$  are said to be equivalent if and only if for every possible input sequence, the same output sequence will be produced regardless of whether  $S_i$  or  $S_j$  is the initial state.”

# **Partition Minimization Procedure**

# 0-successor

Assuming that we have only one input signal  $w$

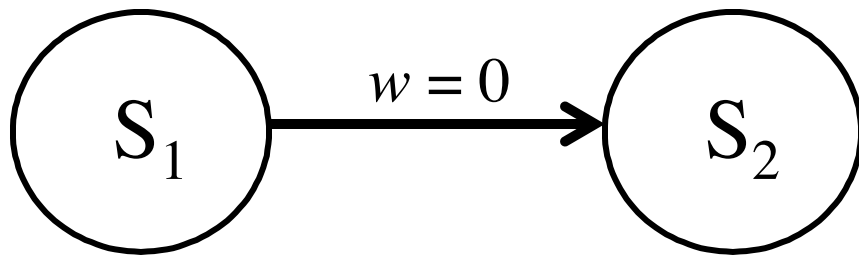

$S_2$  is a 0-successor of  $S_1$



# 0-successor

Assuming that we have only one input signal  $w$

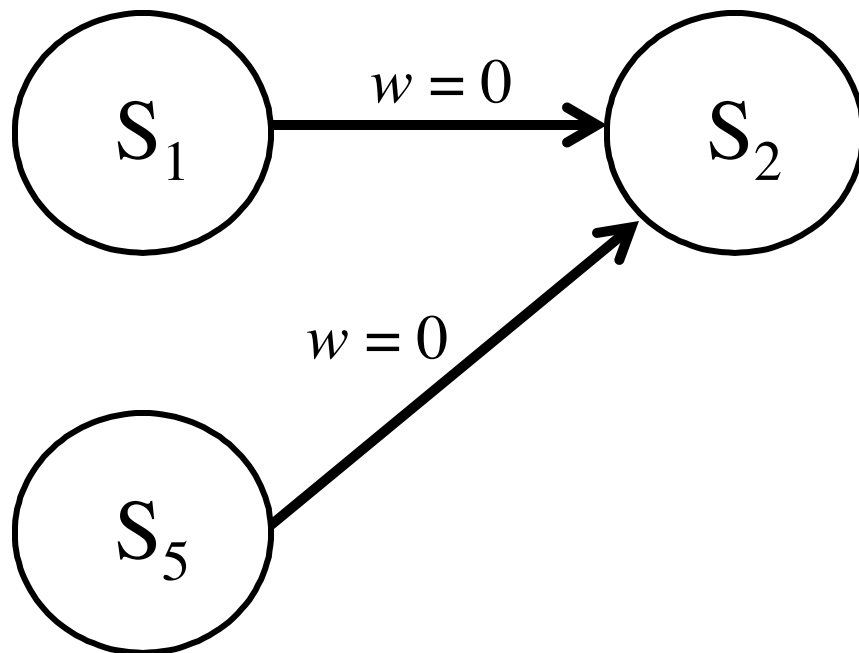

$S_2$  is a 0-successor of  $S_1$

$S_2$  is a 0-successor of  $S_5$

# 1-successor

Assuming that we have only one input signal  $w$

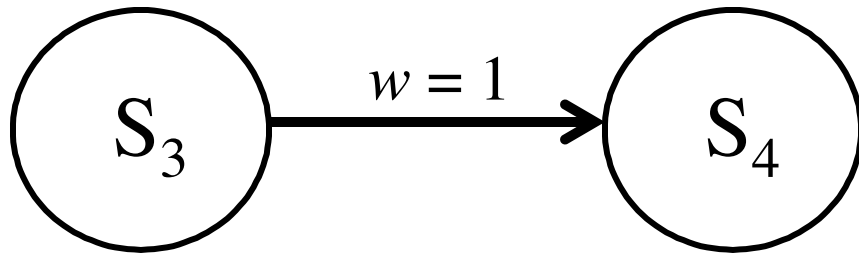

$S_4$  is a 1-successor of  $S_3$

# 1-successor

Assuming that we have only one input signal  $w$

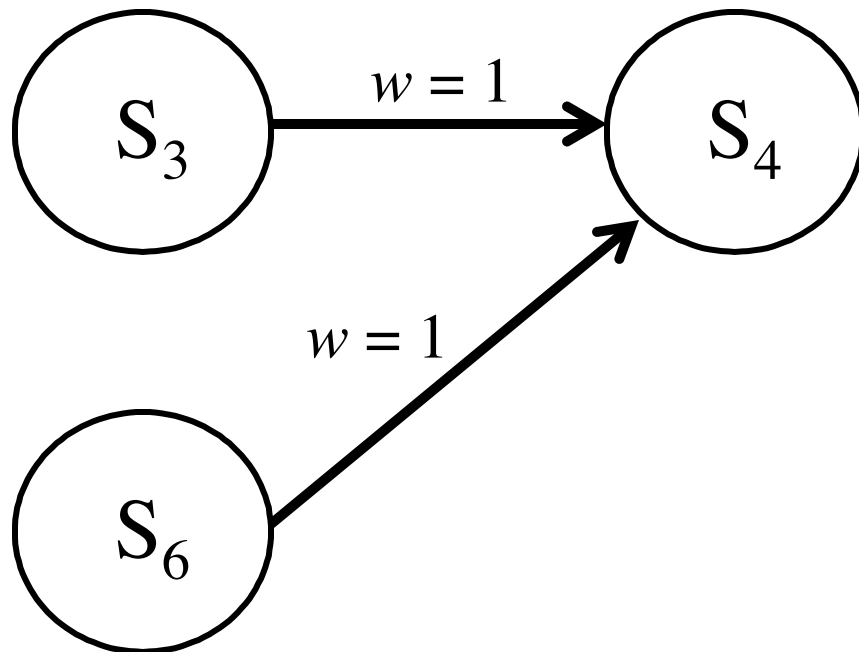

$S_4$  is a 1-successor of  $S_3$

$S_4$  is a 1-successor of  $S_6$

# 1-successor

Assuming that we have only one input signal  $w$

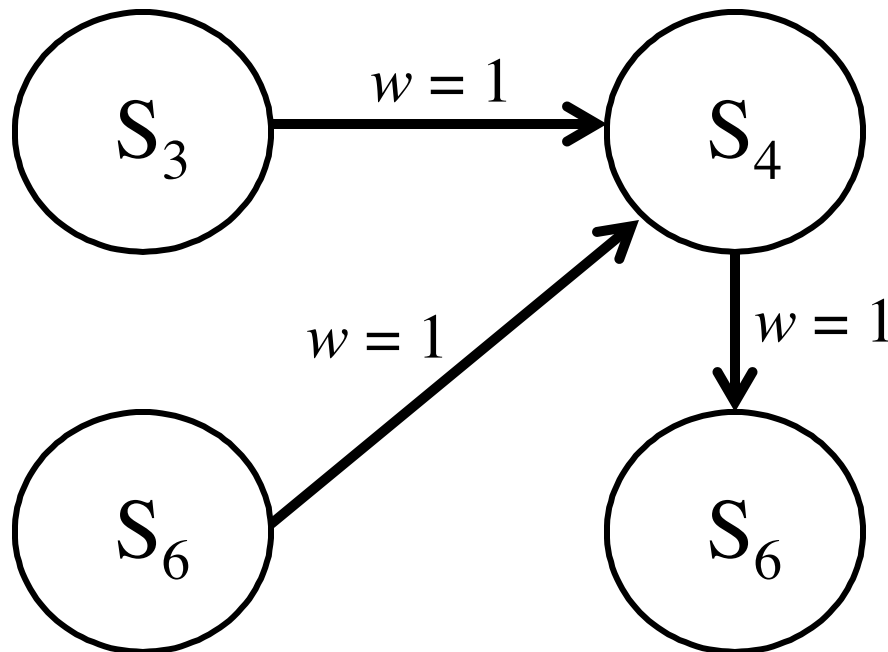

$S_4$  is a 1-successor of  $S_3$

$S_4$  is a 1-successor of  $S_6$

$S_6$  is a 1-successor of  $S_4$

# **k-successors of a State**

**Assuming that we have only one input signal  $w$ , then  $k$  can only be equal to 0 or 1.**

# k-successors of a State

Assuming that we have only one input signal  $w$ , then  $k$  can only be equal to 0 or 1.

In other words, this is the familiar 0-successor or 1-successor case.

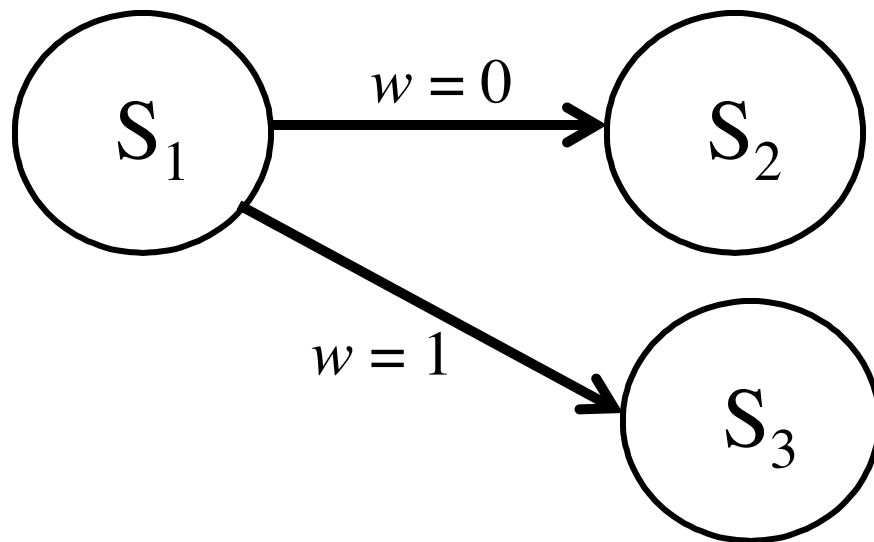

$S_2$  is a 0-successor of  $S_1$

$S_3$  is a 1-successor of  $S_1$

# **k-successors of a State**

**If we have two input signals, e.g.,  $w_0$  and  $w_1$ , then  $k$  can only be equal to 0,1, 2, or 3.**

# k-successors of a State

If we have two input signals, e.g.,  $w_0$  and  $w_1$ , then  $k$  can only be equal to 0, 1, 2, or 3.

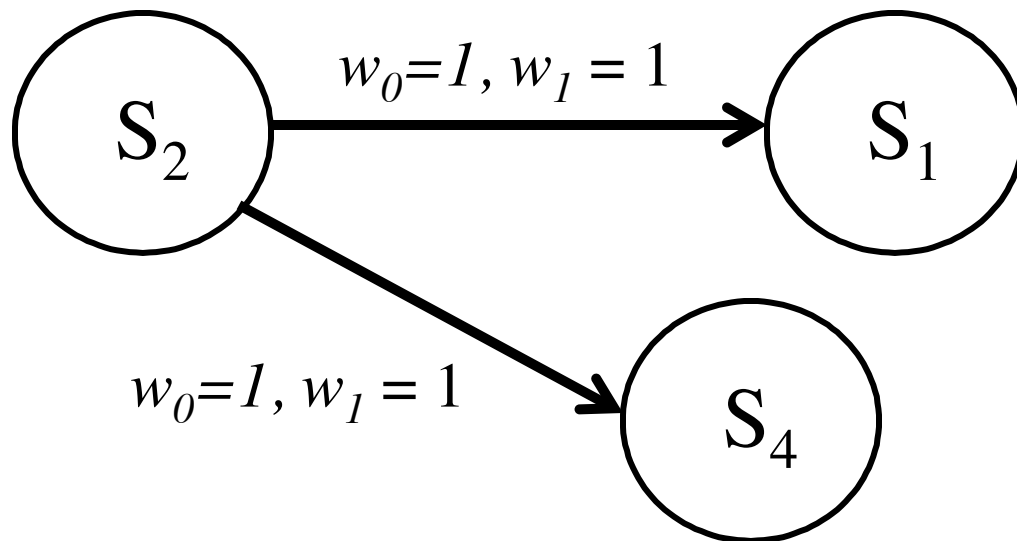

$S_1$  is a 3-successor of  $S_2$

$S_4$  is a 3-successor of  $S_2$



# Equivalence of states

“If states  $S_i$  and  $S_j$  are equivalent, then their corresponding  $k$ -successors (for all  $k$ ) are also equivalent.”

# Partition

**“A partition consists of one or more blocks, where each block comprises a subset of states that may be equivalent, but the states in a given block are definitely not equivalent to the states in other blocks.”**

# State Table for This Example

Present state	Next state		Output $z$
	$w = 0$	$w = 1$	
A	B	C	1
B	D	F	1
C	F	E	0
D	B	G	1
E	F	C	0
F	E	D	0
G	F	G	0

# State Diagram (just the states)

Present state	Next state		Output $z$
	$w = 0$	$w = 1$	
A	B	C	1
B	D	F	1
C	F	E	0
D	B	G	1
E	F	C	0
F	E	D	0
G	F	G	0

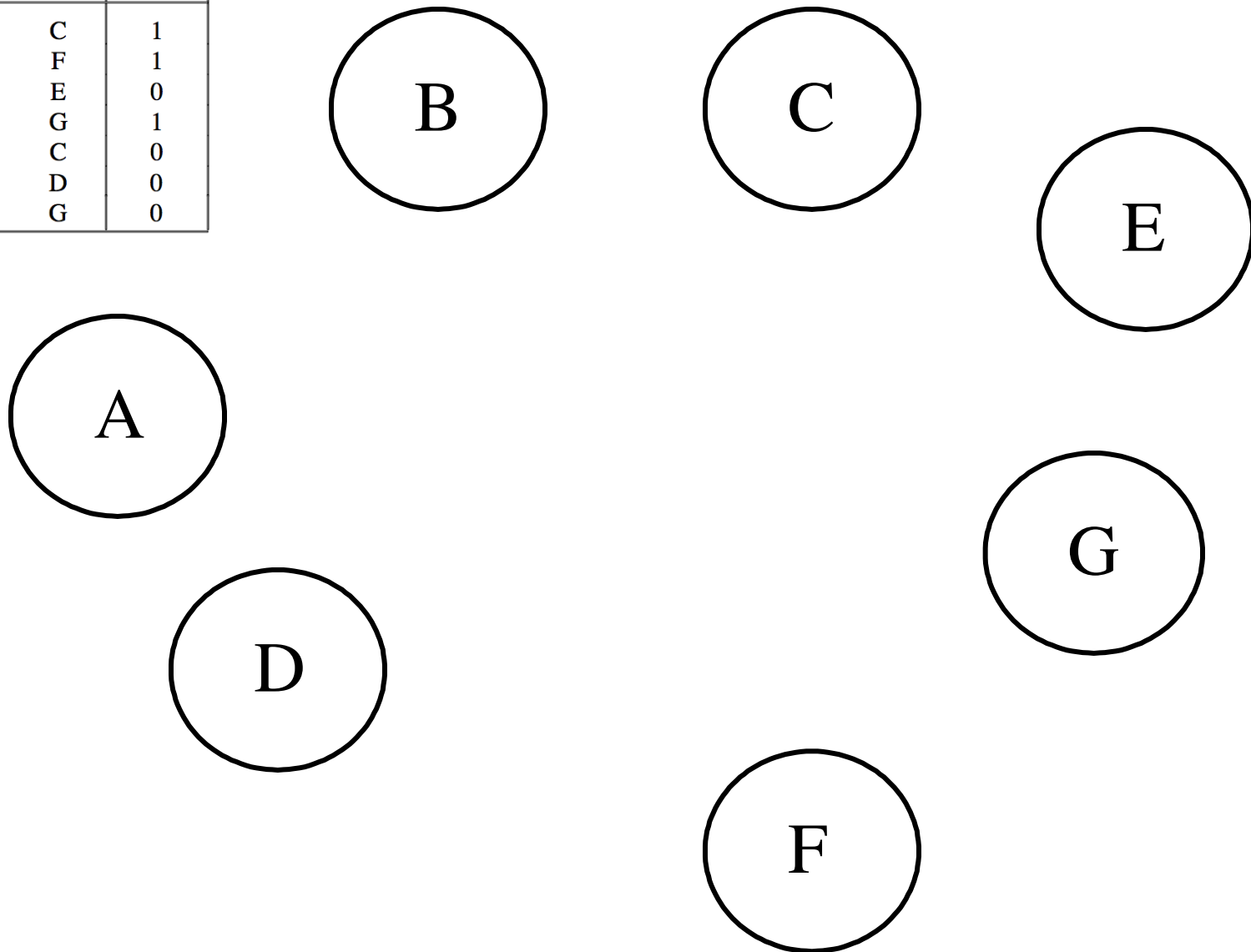

# State Diagram (transitions when $w=0$ )

Present state	Next state		Output $z$
	$w = 0$	$w = 1$	
A	B	C	1
B	D	F	1
C	F	E	0
D	B	G	1
E	F	C	0
F	E	D	0
G	F	G	0

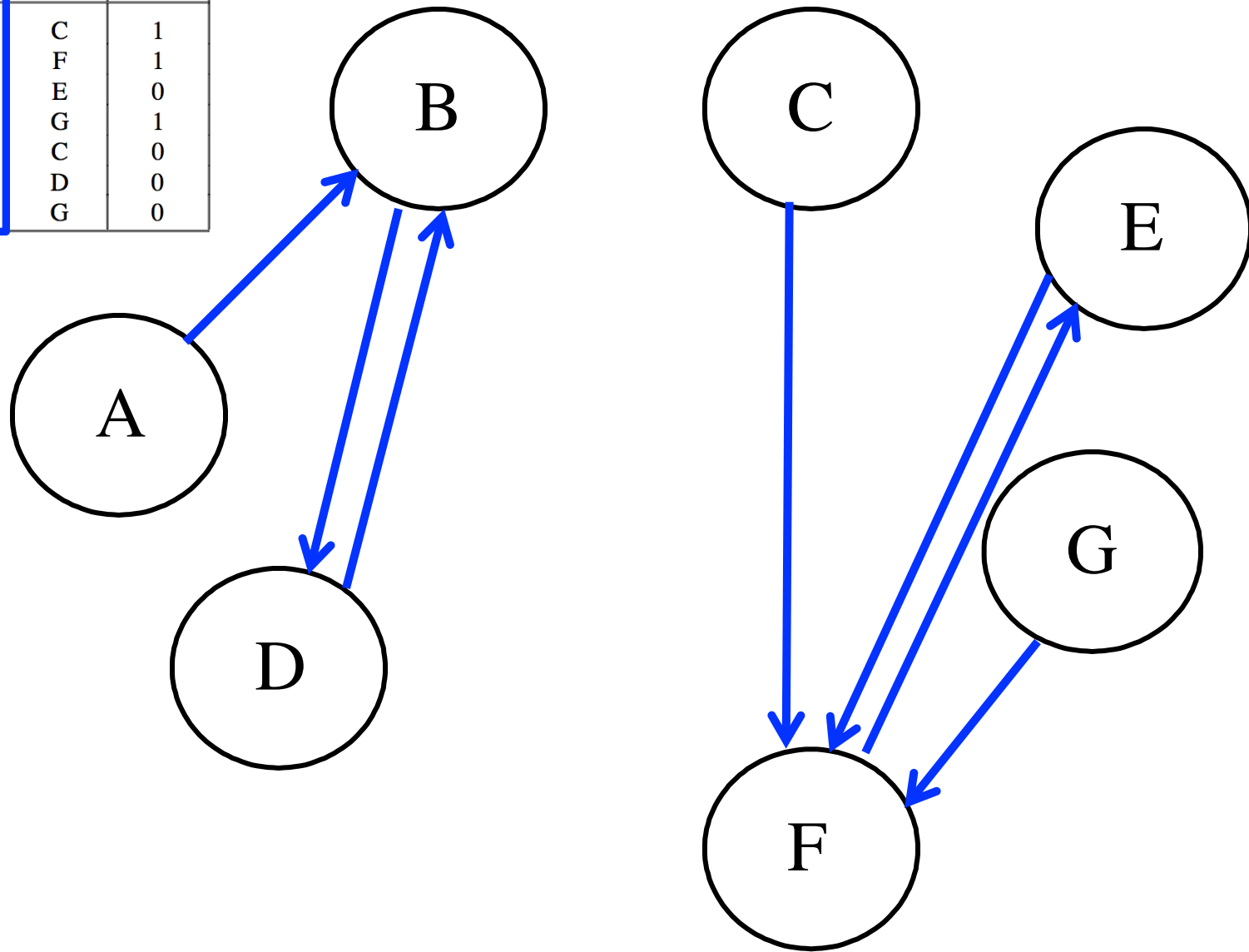

# State Diagram (transitions when $w=1$ )

Present state	Next state		Output $z$
	$w = 0$	$w = 1$	
A	B	C	1
B	D	F	1
C	F	E	0
D	B	G	1
E	F	C	0
F	E	D	0
G	F	G	0

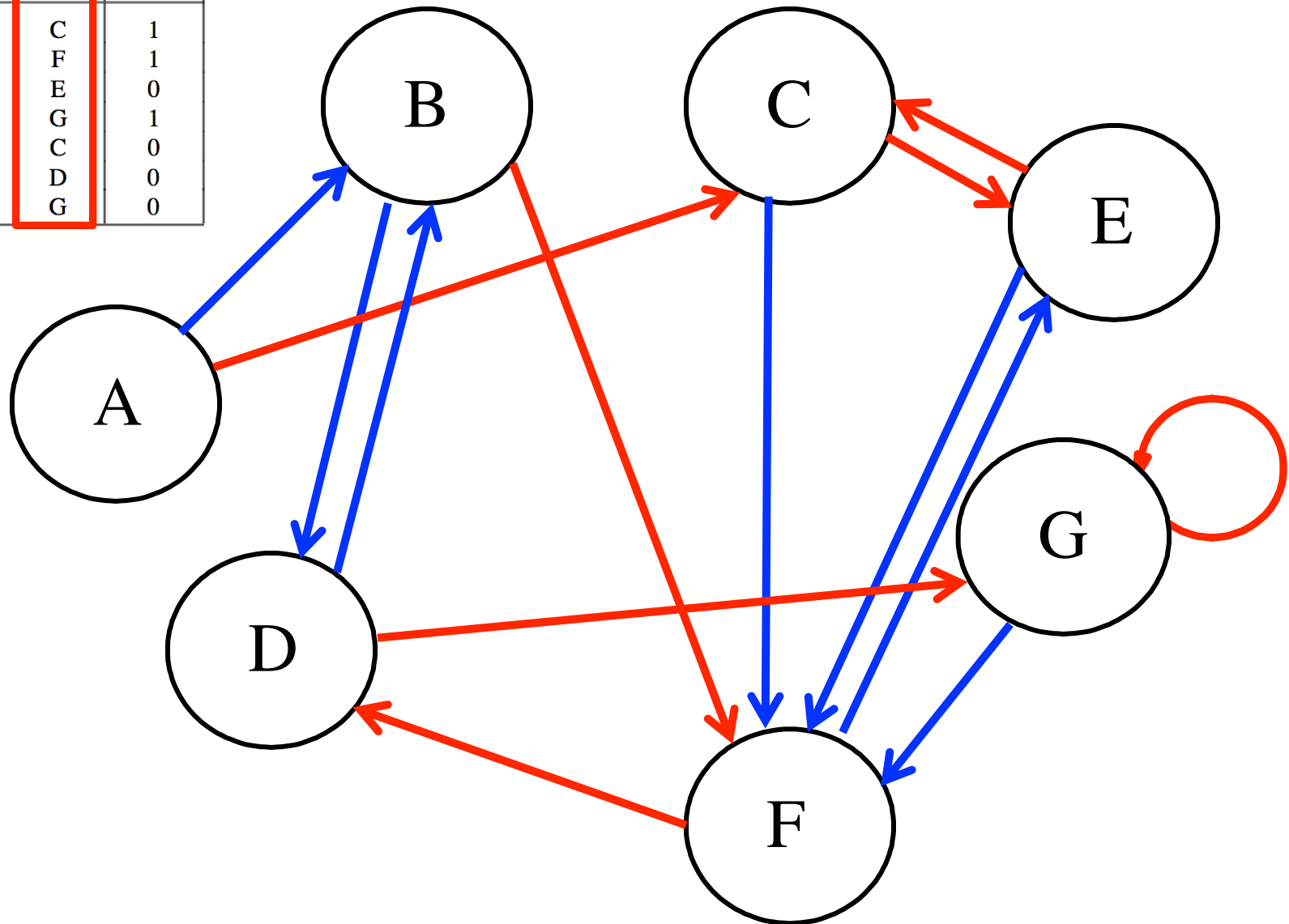

# Outputs

Present state	Next state		Output
	$w = 0$	$w = 1$	$z$
A	B	C	1
B	D	F	1
C	F	E	0
D	B	G	1
E	F	C	0
F	E	D	0
G	F	G	0

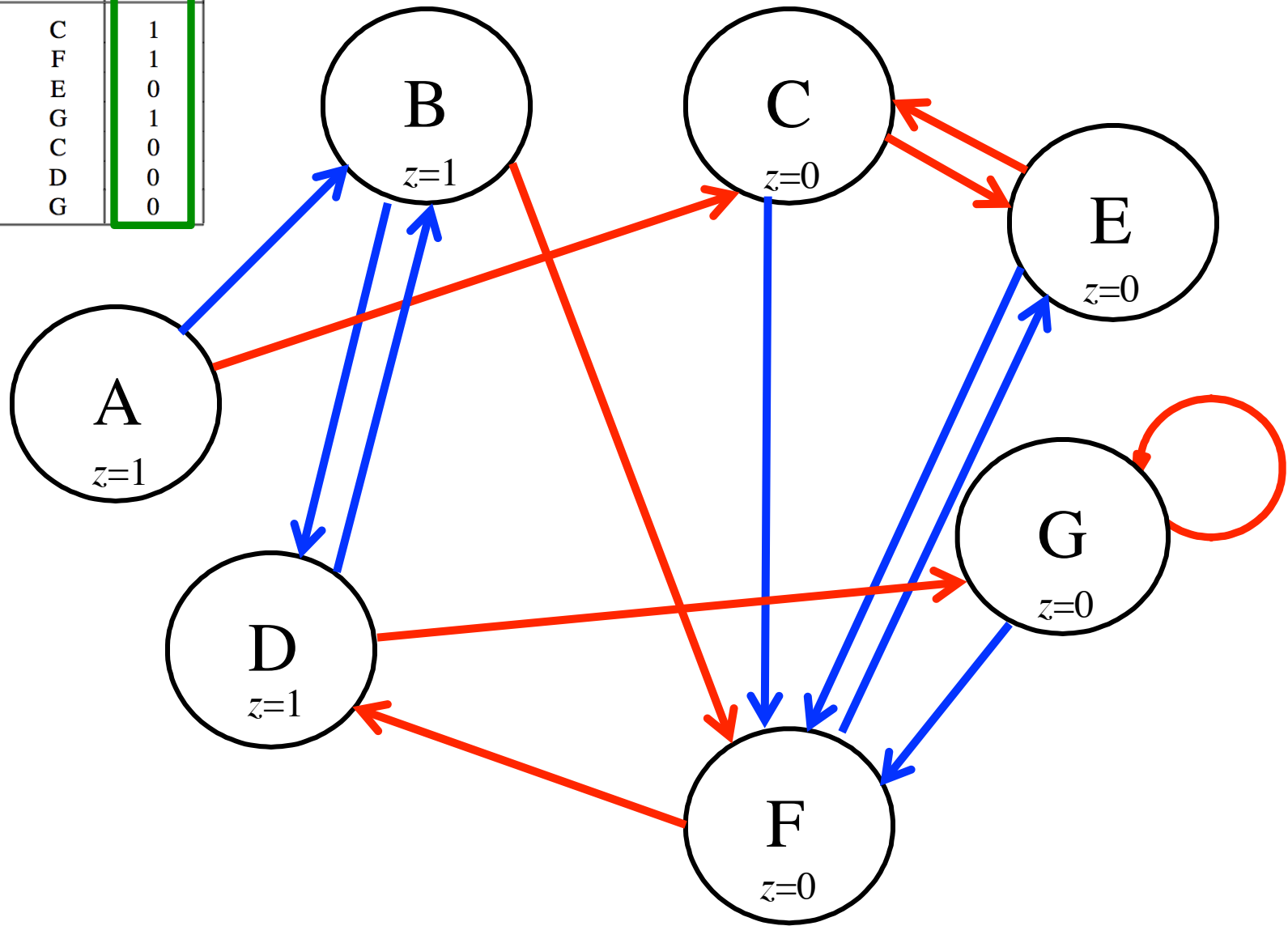

# Partition #1

(All states in the same partition)

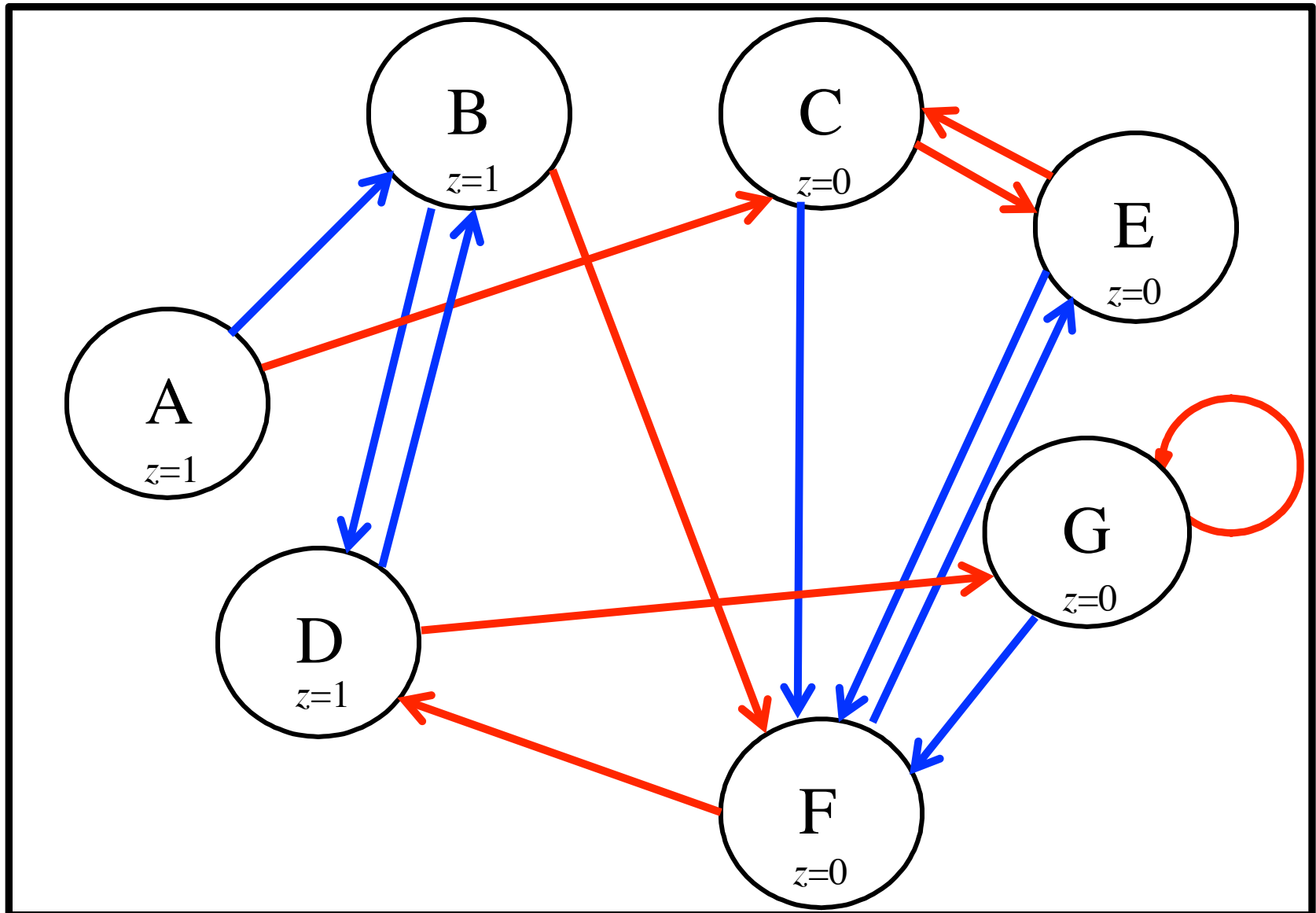



# Partition #1

(ABCDEFGG)

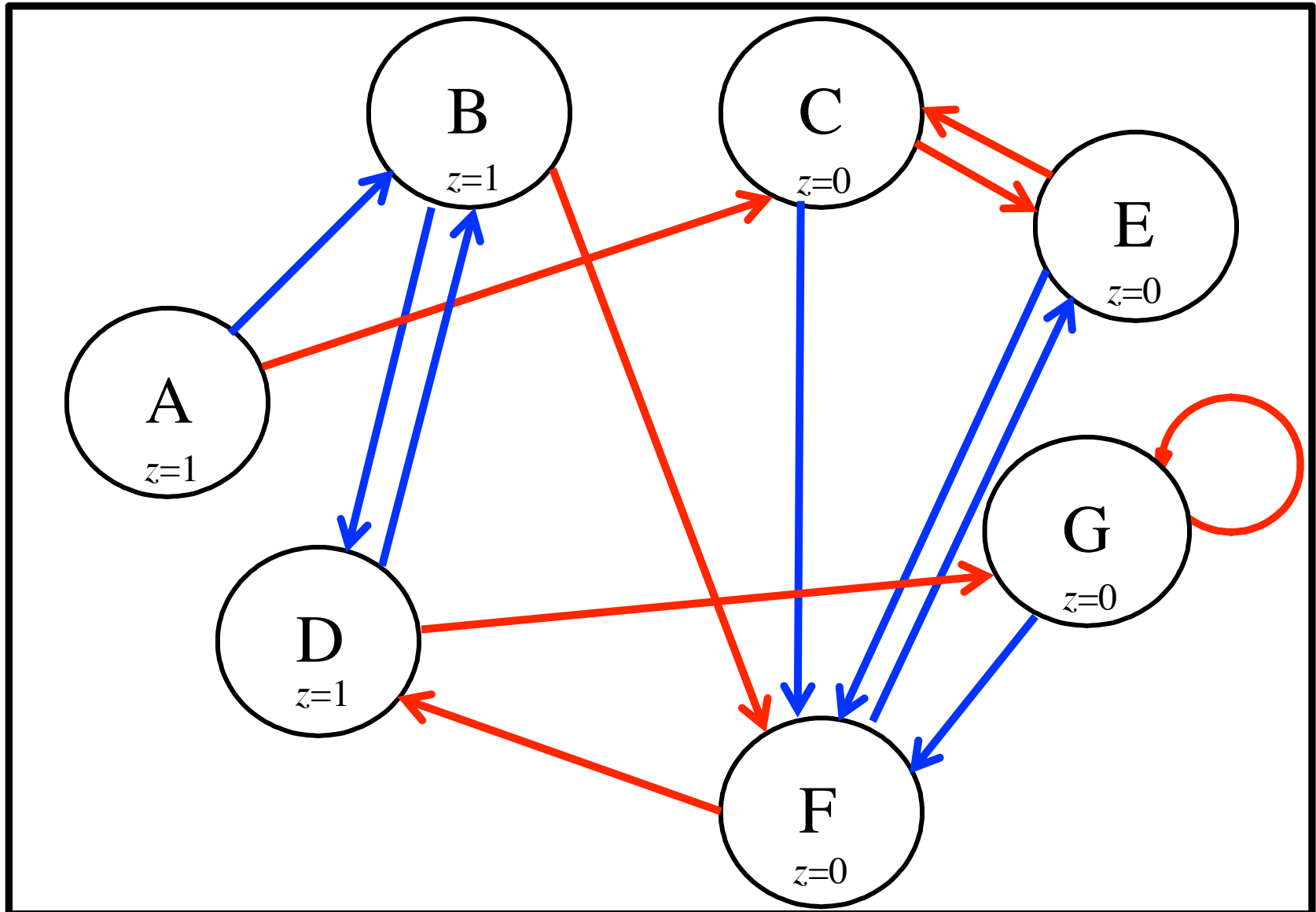

# Partition #2

(based on outputs)

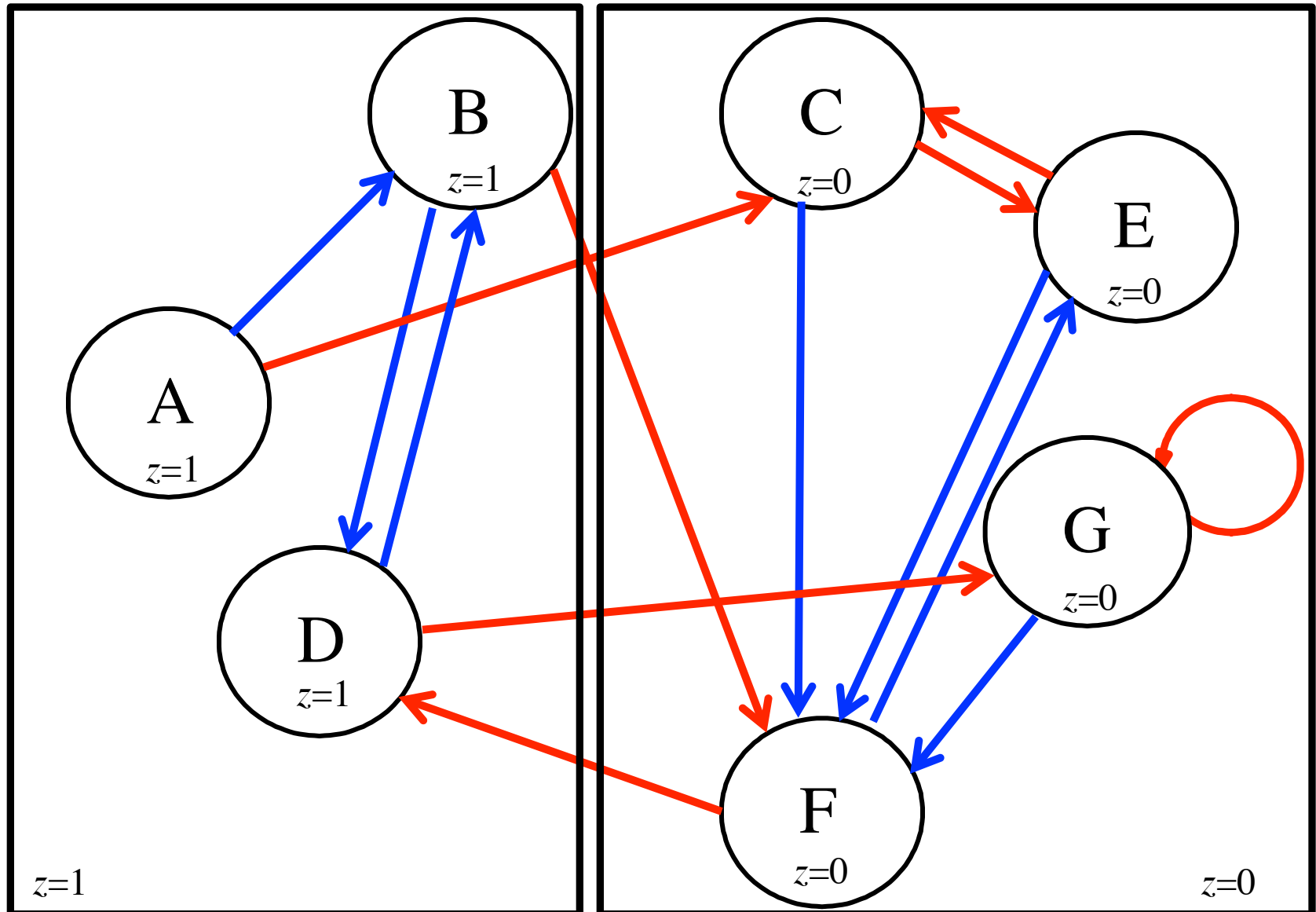

# Partition #2

(ABD)(CEFG)

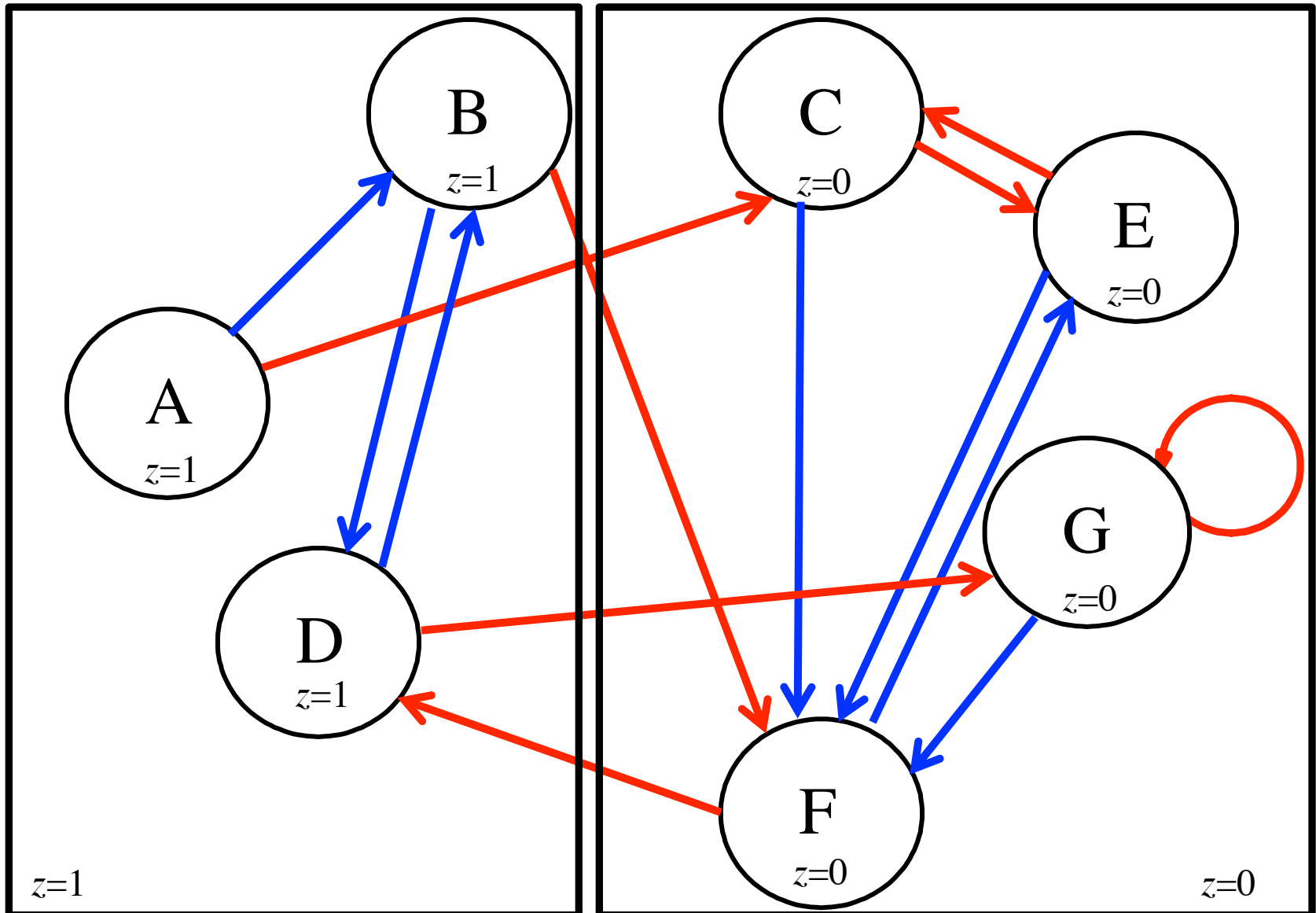

# Partition #3.1

(Examine the 0-successors of ABD)

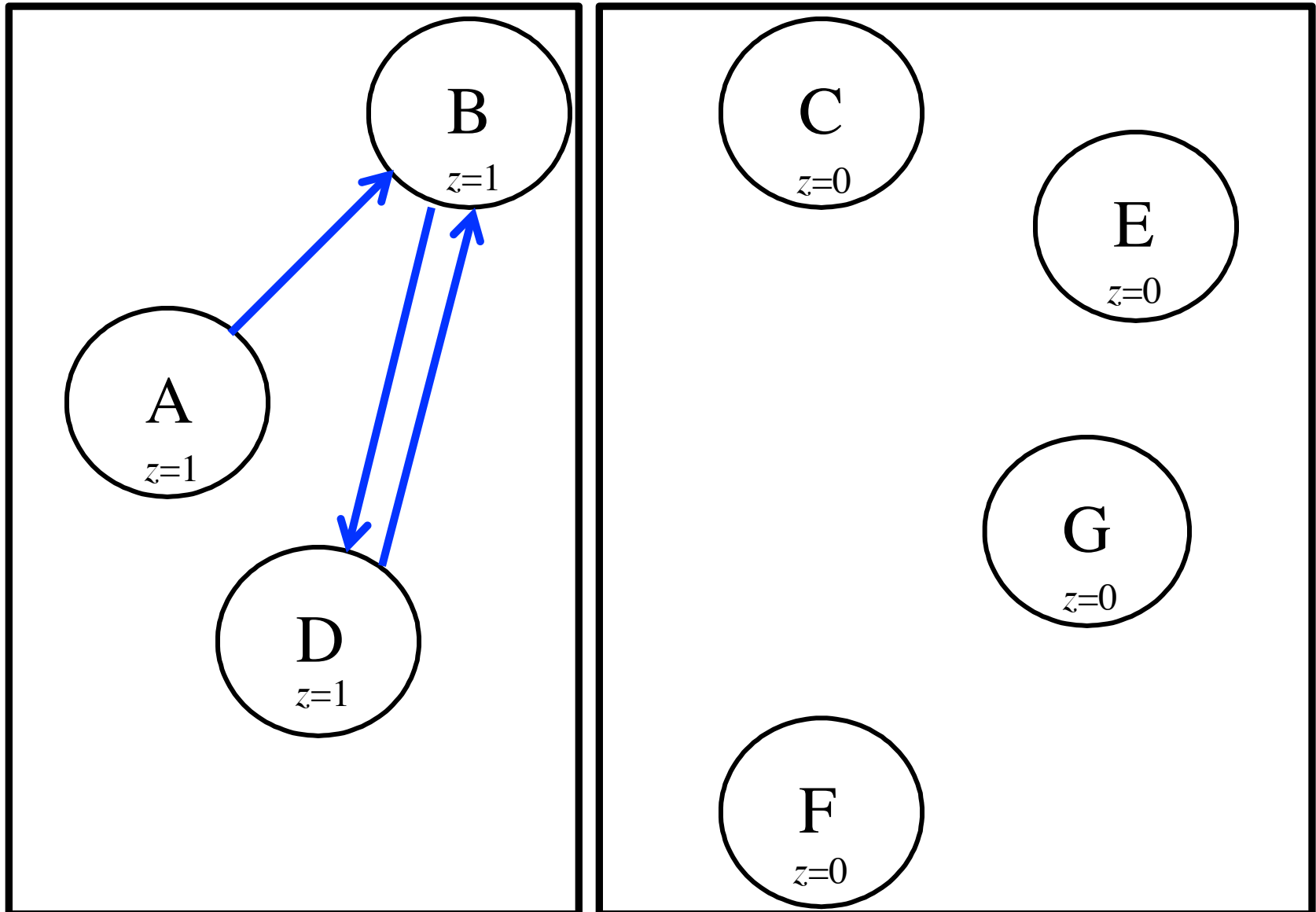

# Partition #3.1

(Examine the 1-successors of ABD)

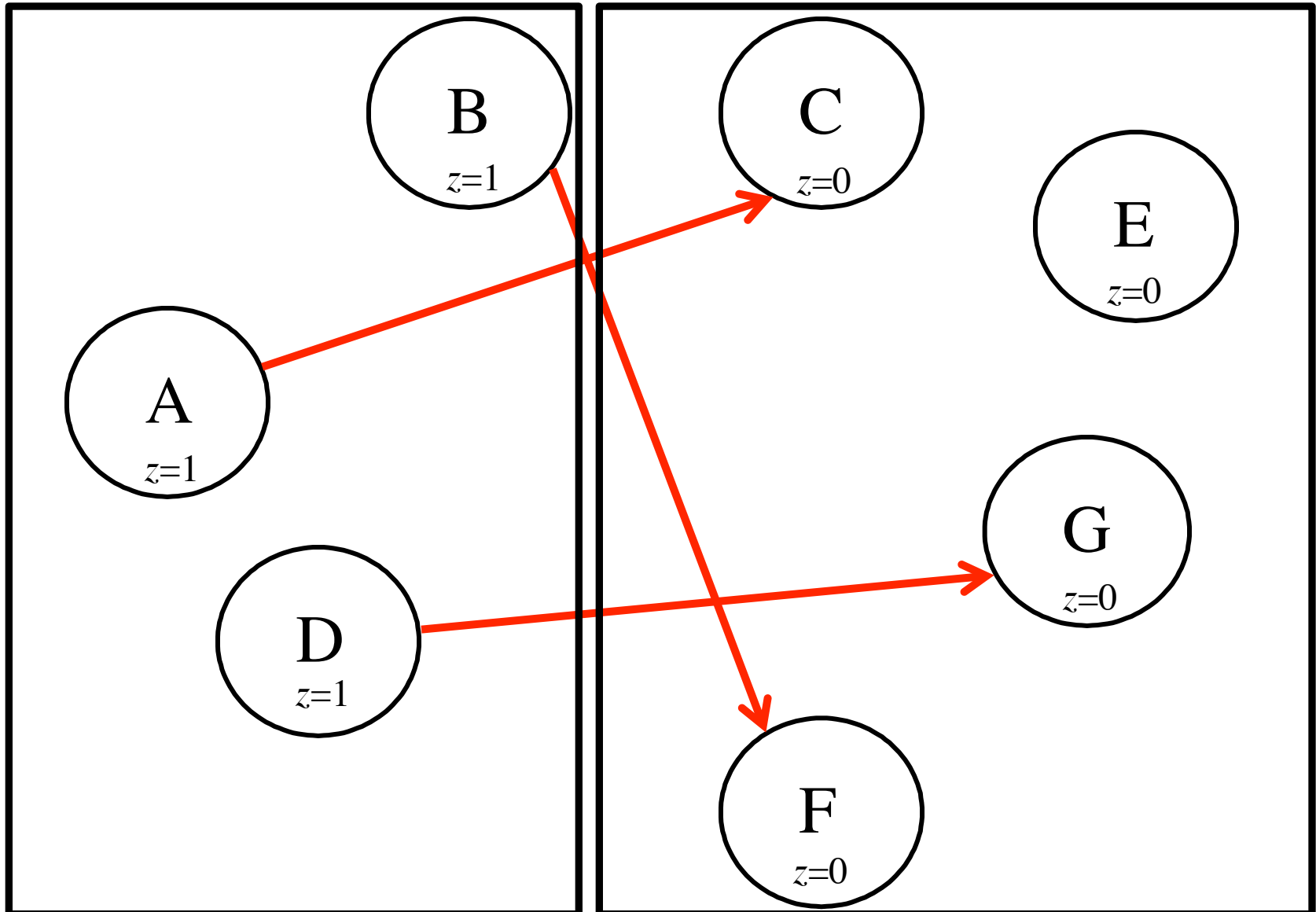

# Partition #3.2

(Examine the 0-successors of CEFG)

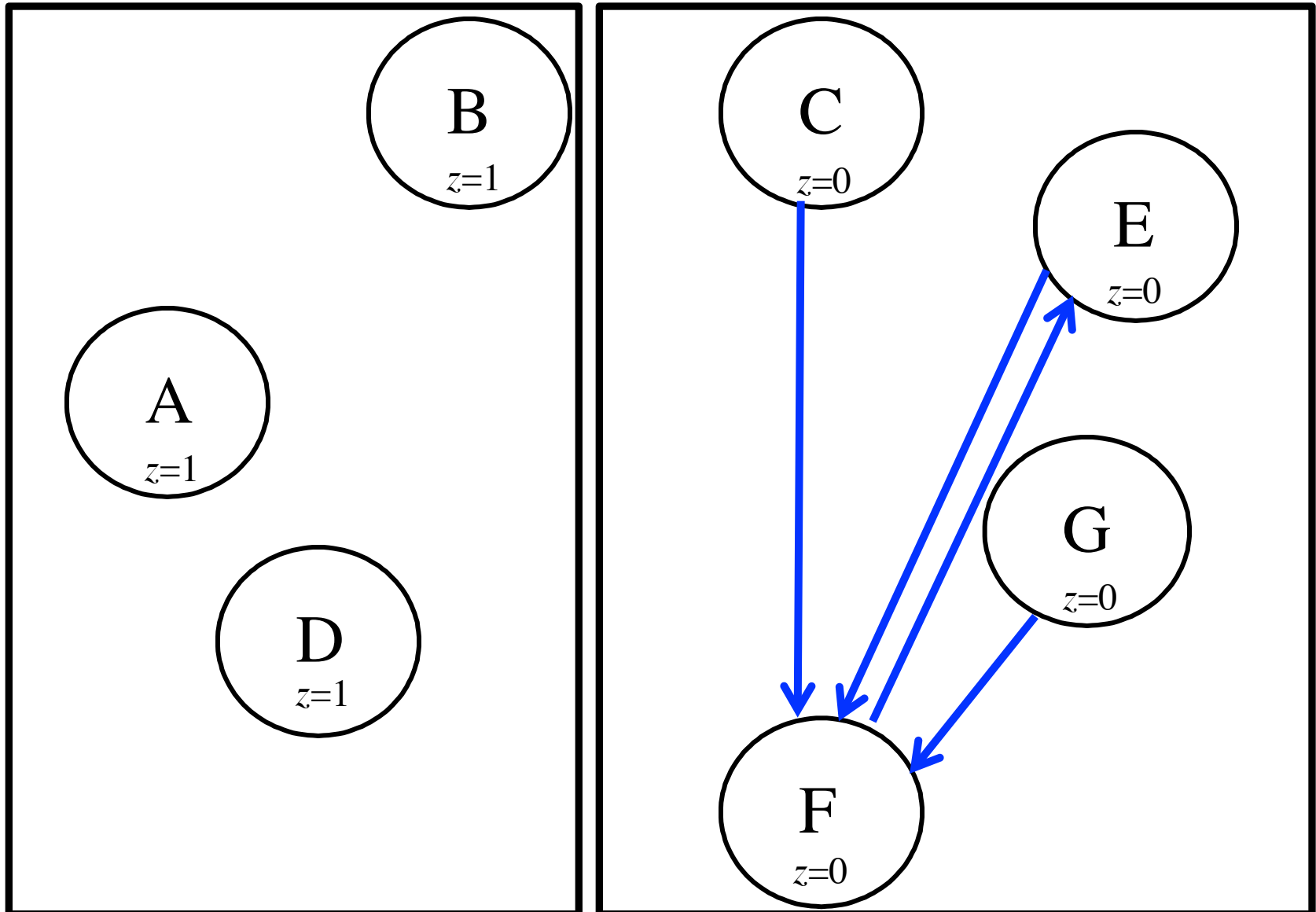

# Partition #3.2

(Examine the 1-successors of CEFG)

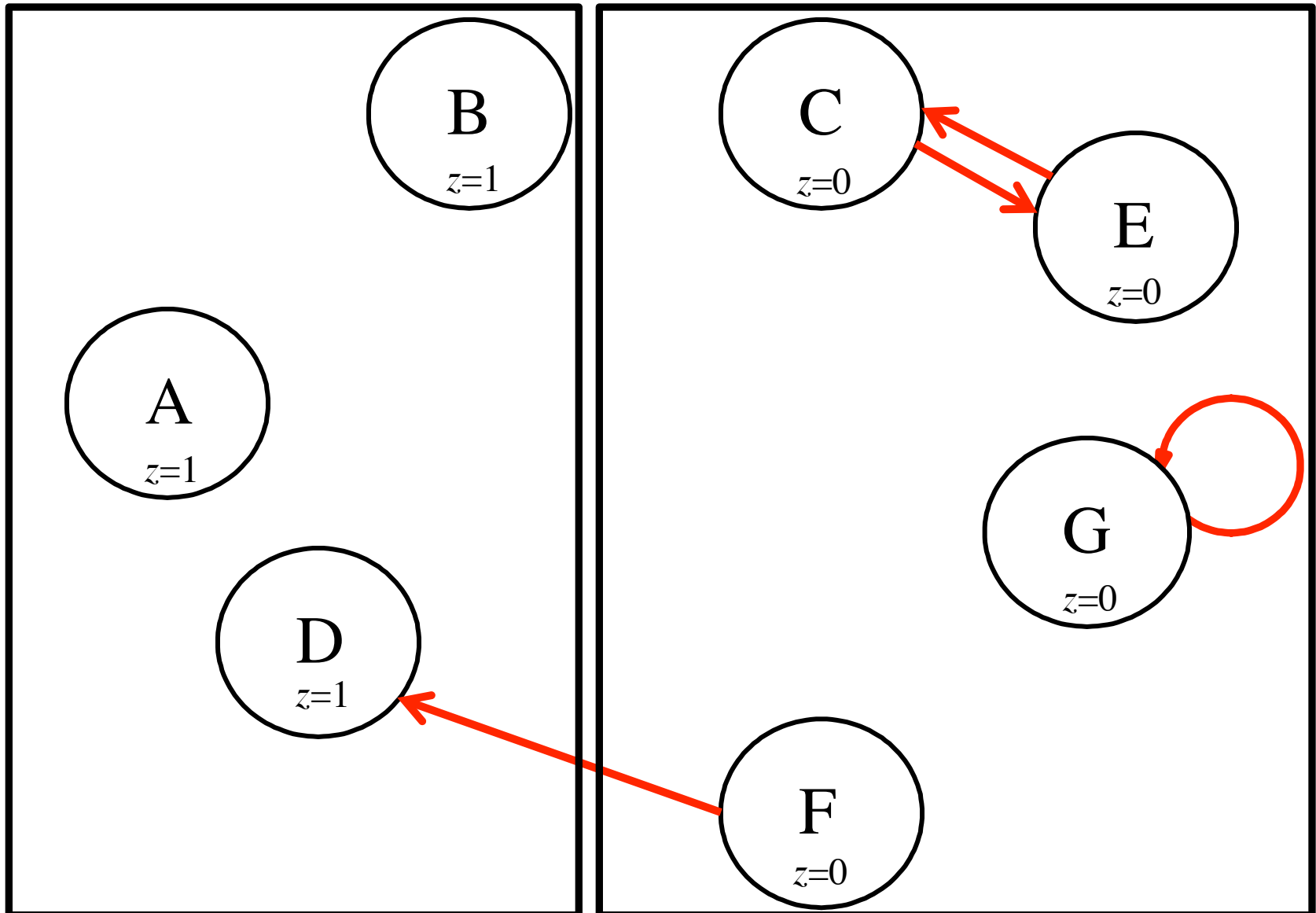

# Partition #3.2

(Examine the 1-successors of CCFG)

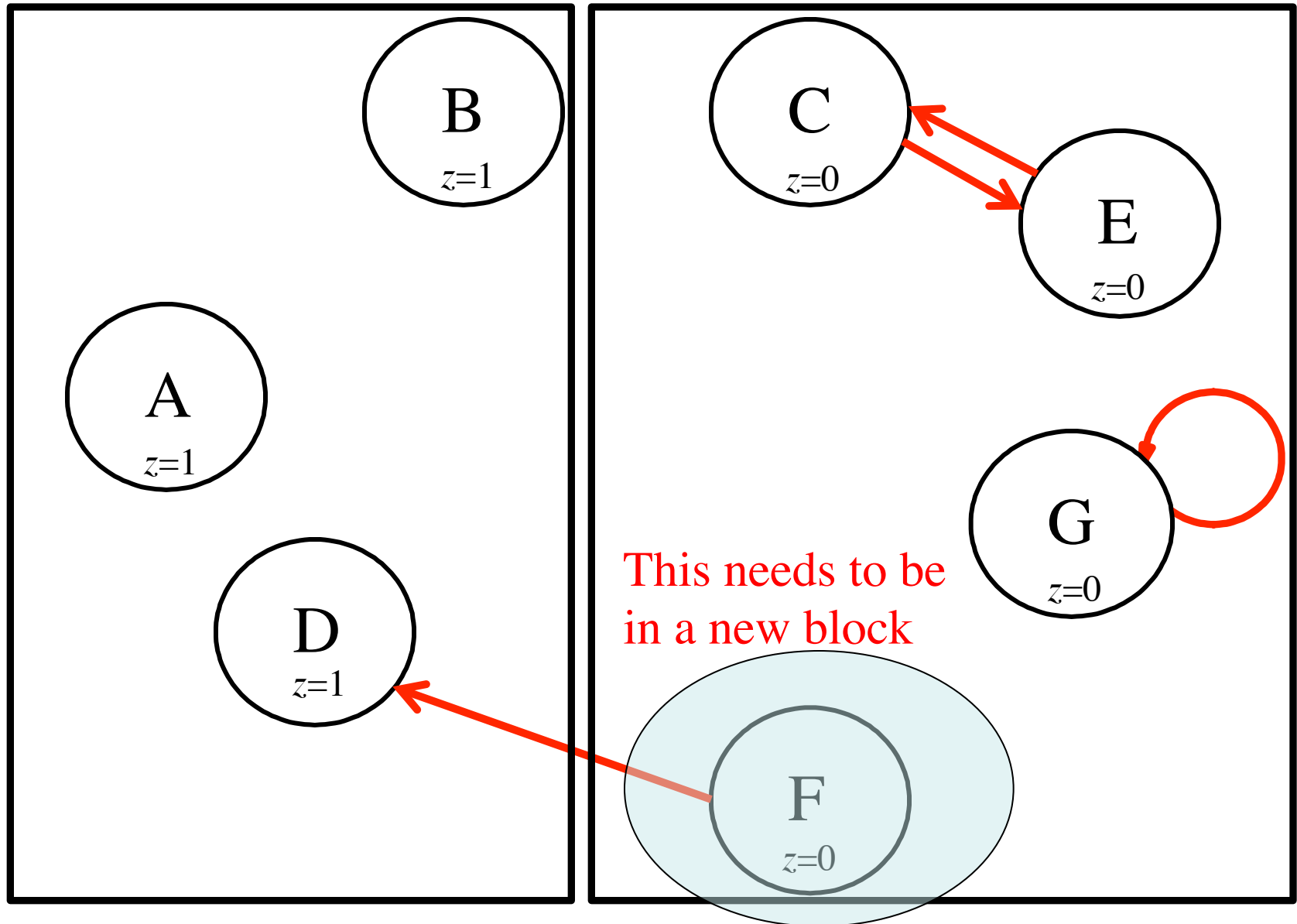



# Partition #3

(ABD)(CEG)(F)

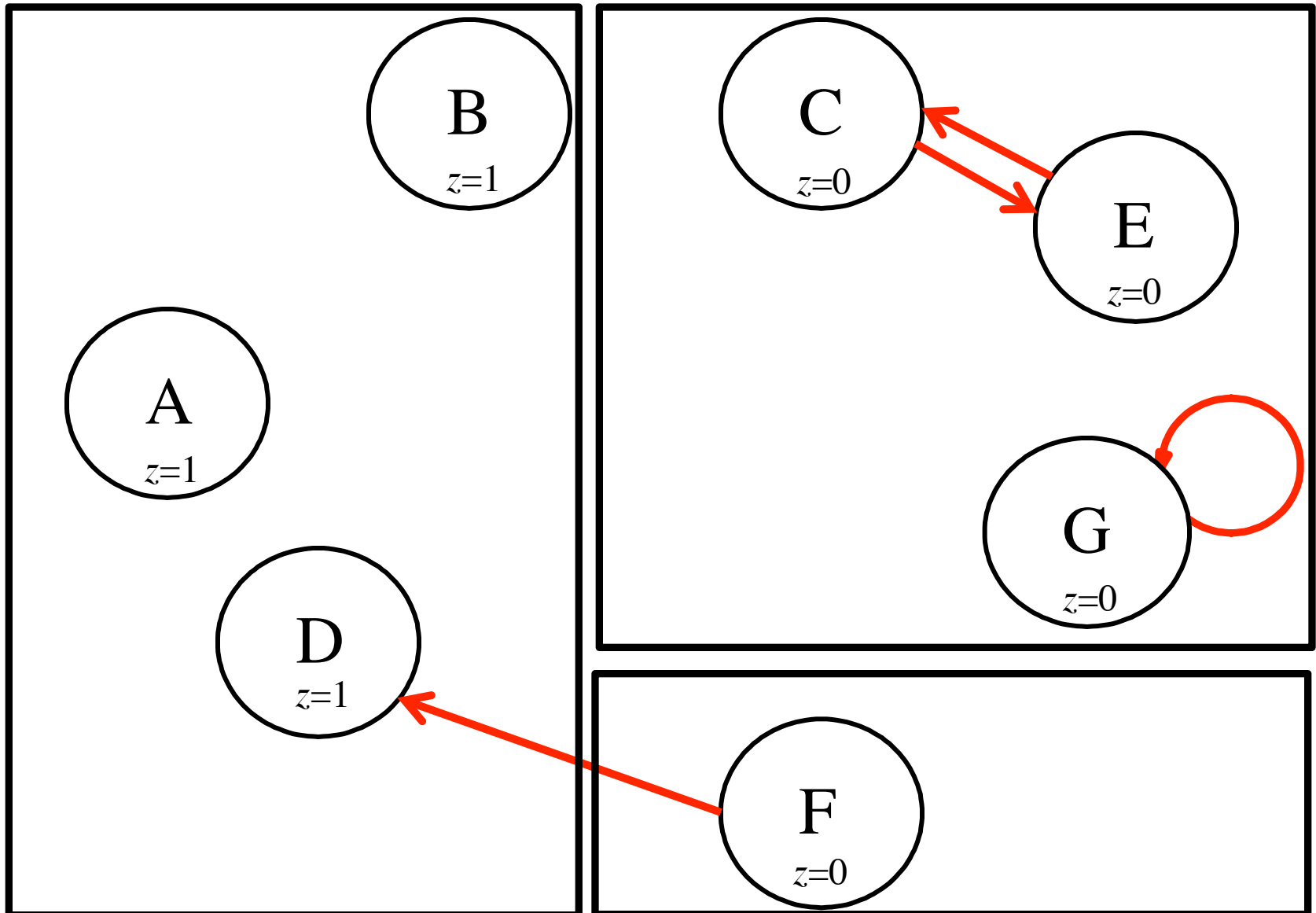

# Partition #3

(ABD)(CEG)(F)

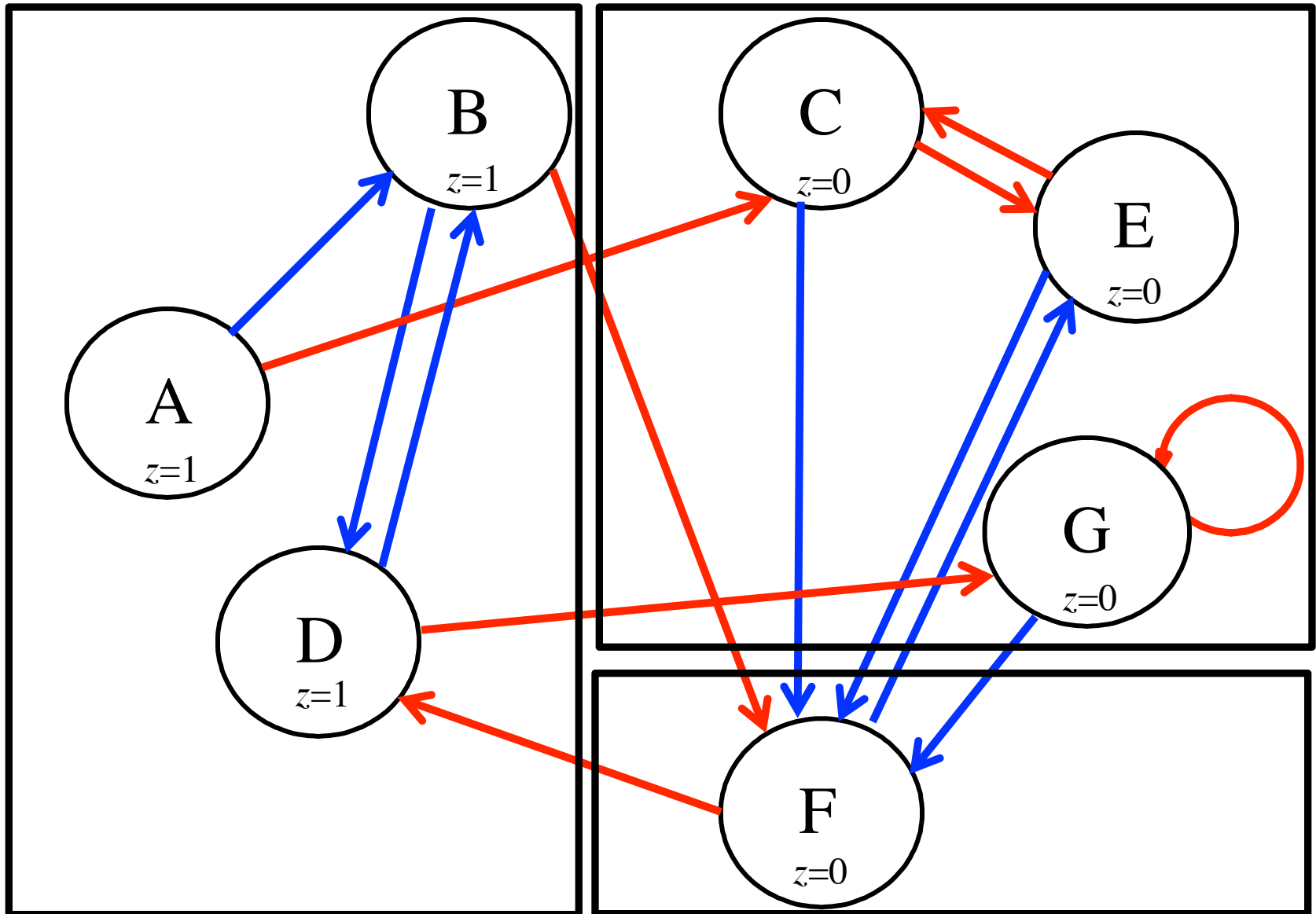

# Partition #4.1

(Examine the 0-successors of ABD)

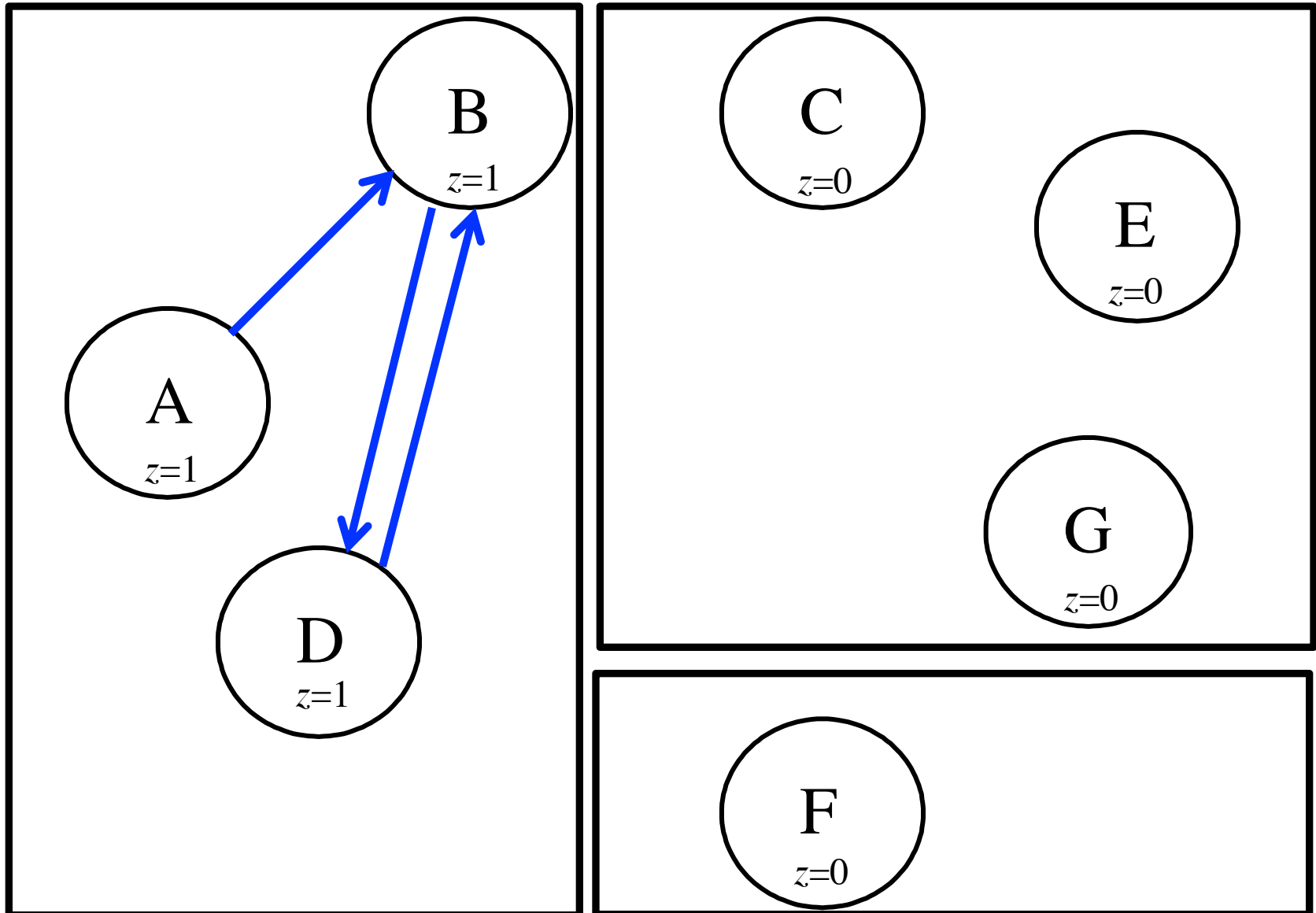

# Partition #4.1

(Examine the 1-successors of ABD)

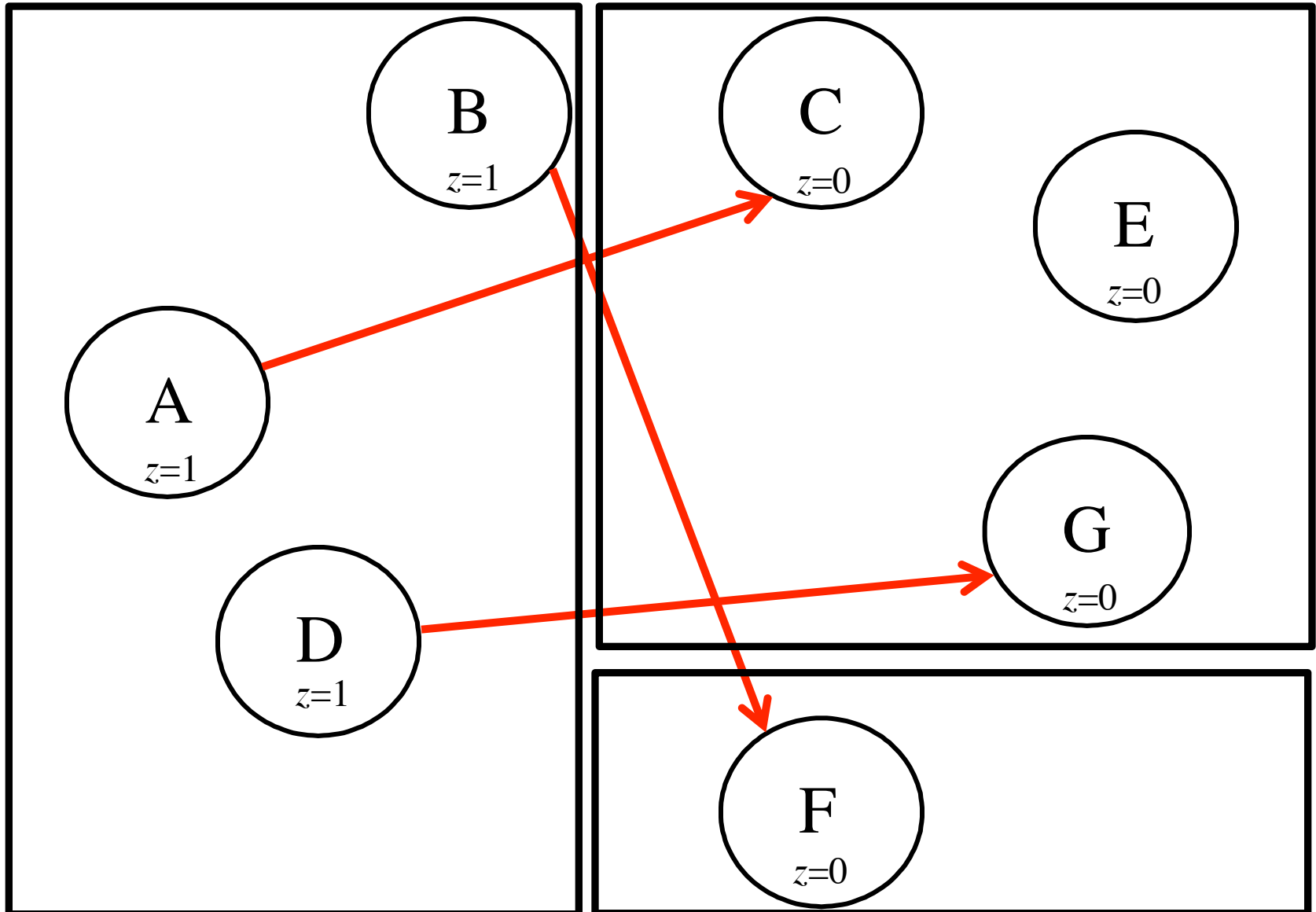

# Partition #4.1

(Examine the 1-successors of ABD)

This needs to be  
in a new block

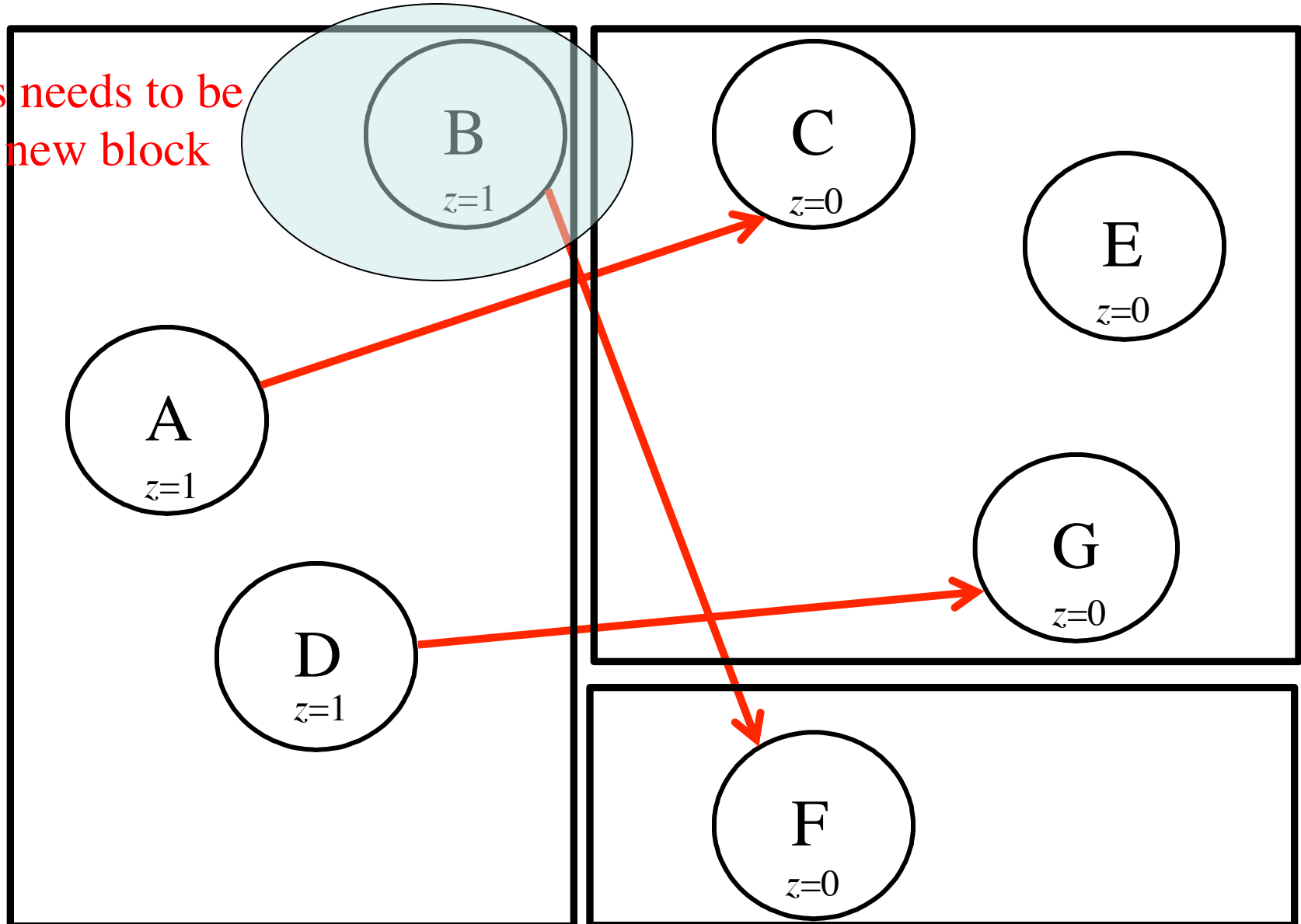

# Partition #4

(AD)(B)(CEG)(F)

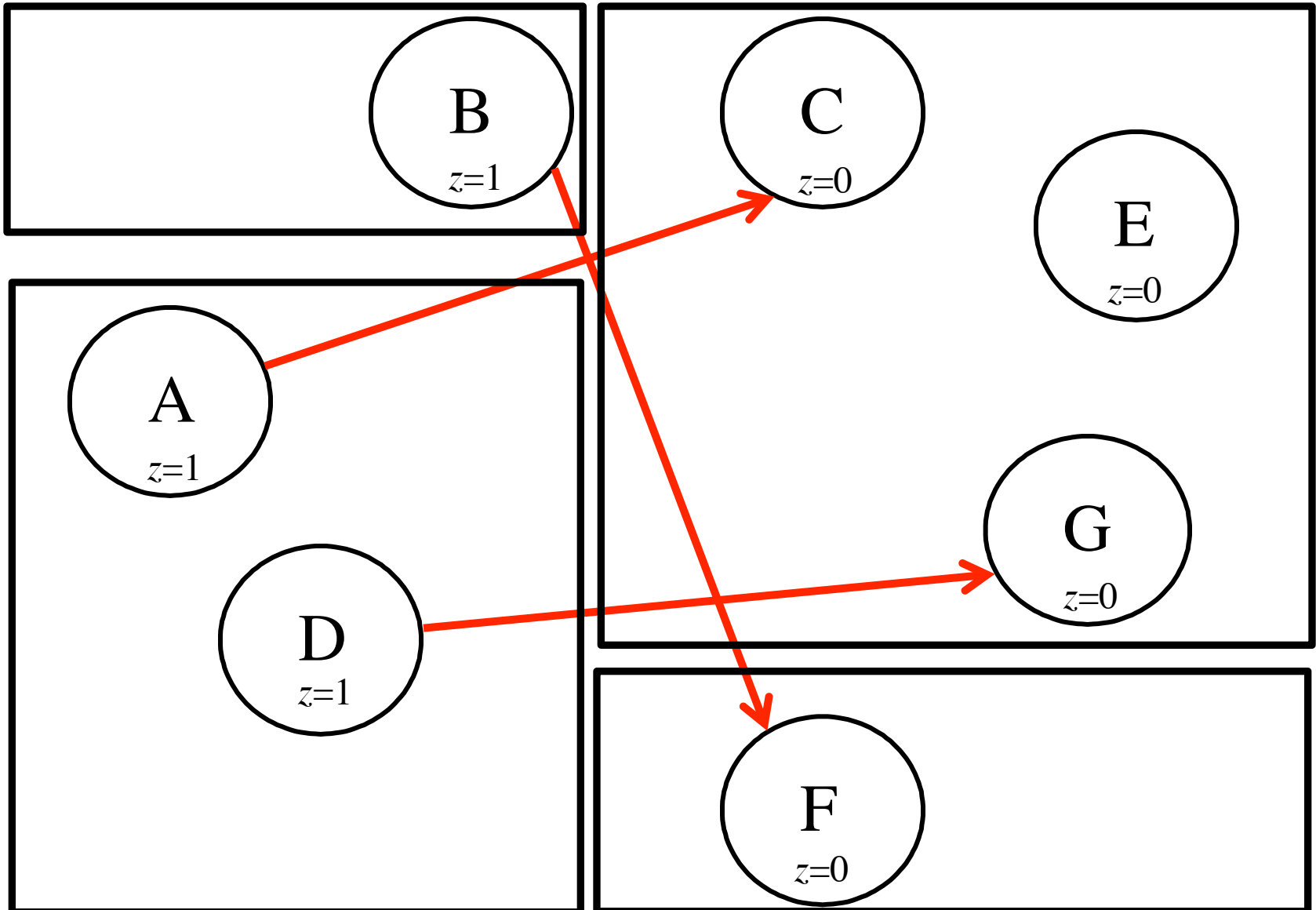

# Partition #4

(AD)(B)(CEG)(F)

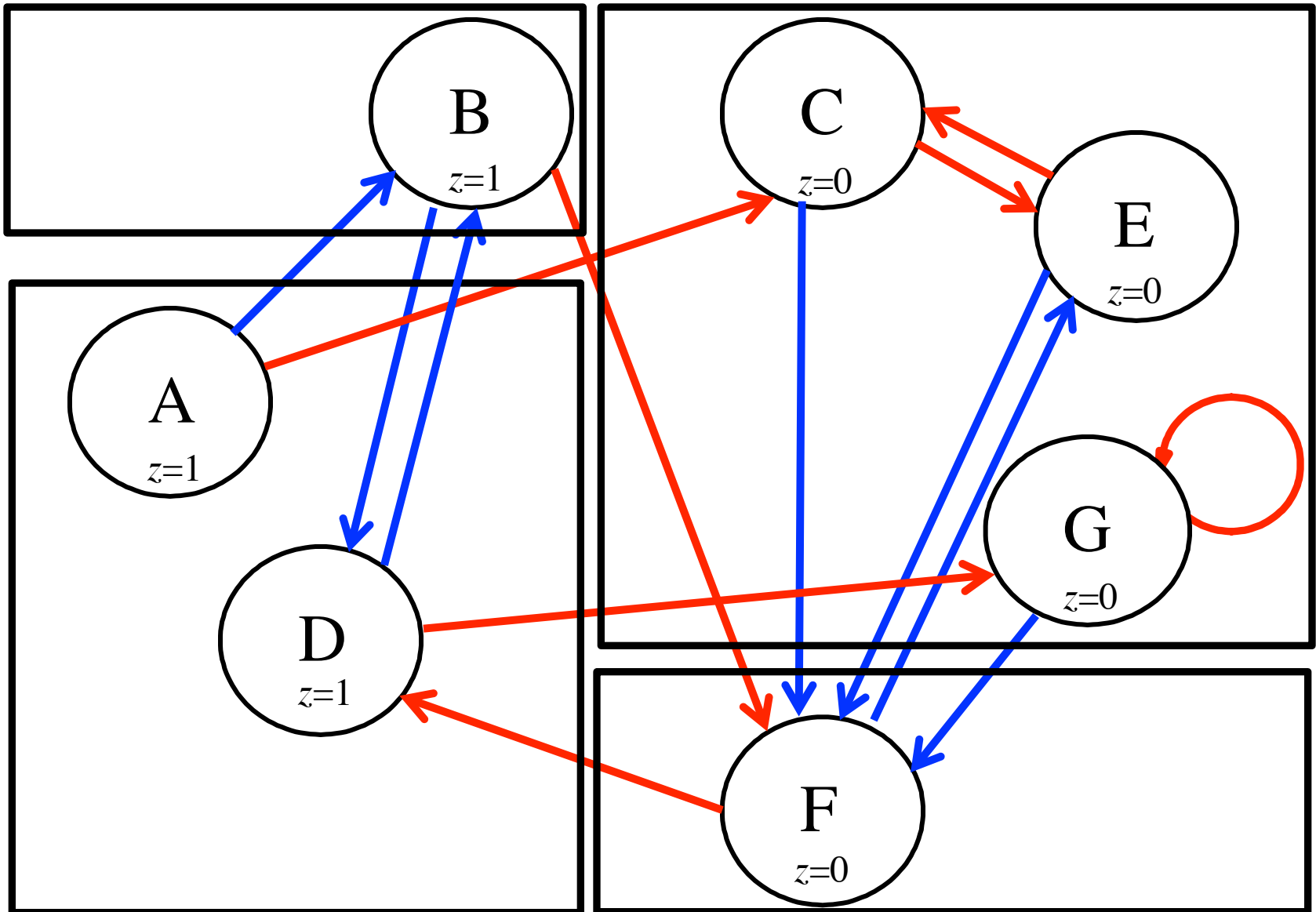

# Partition #5.1

(Examine the 0-successors of AD)

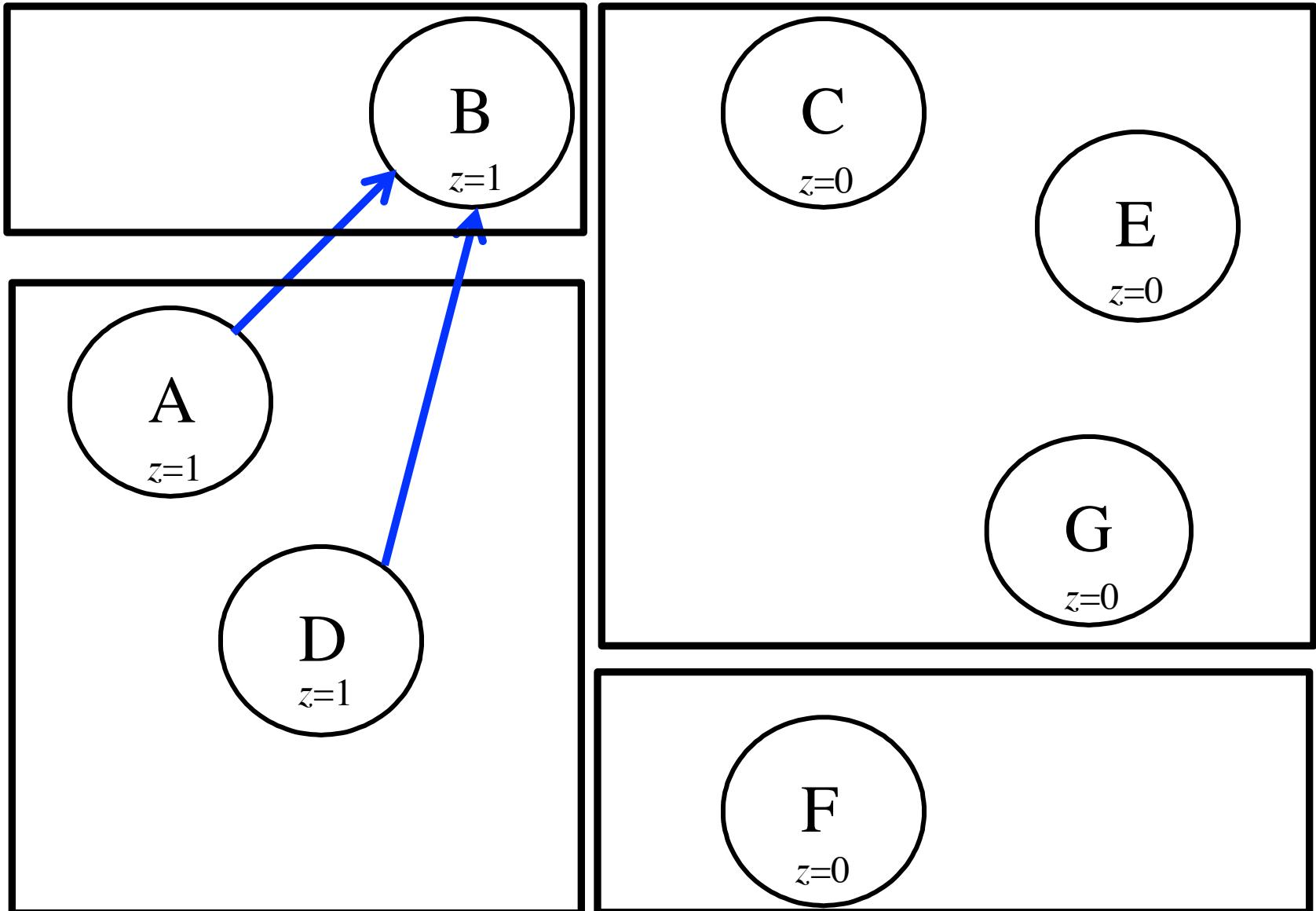



# Partition #5.1

(Examine the 1-successors of AD)

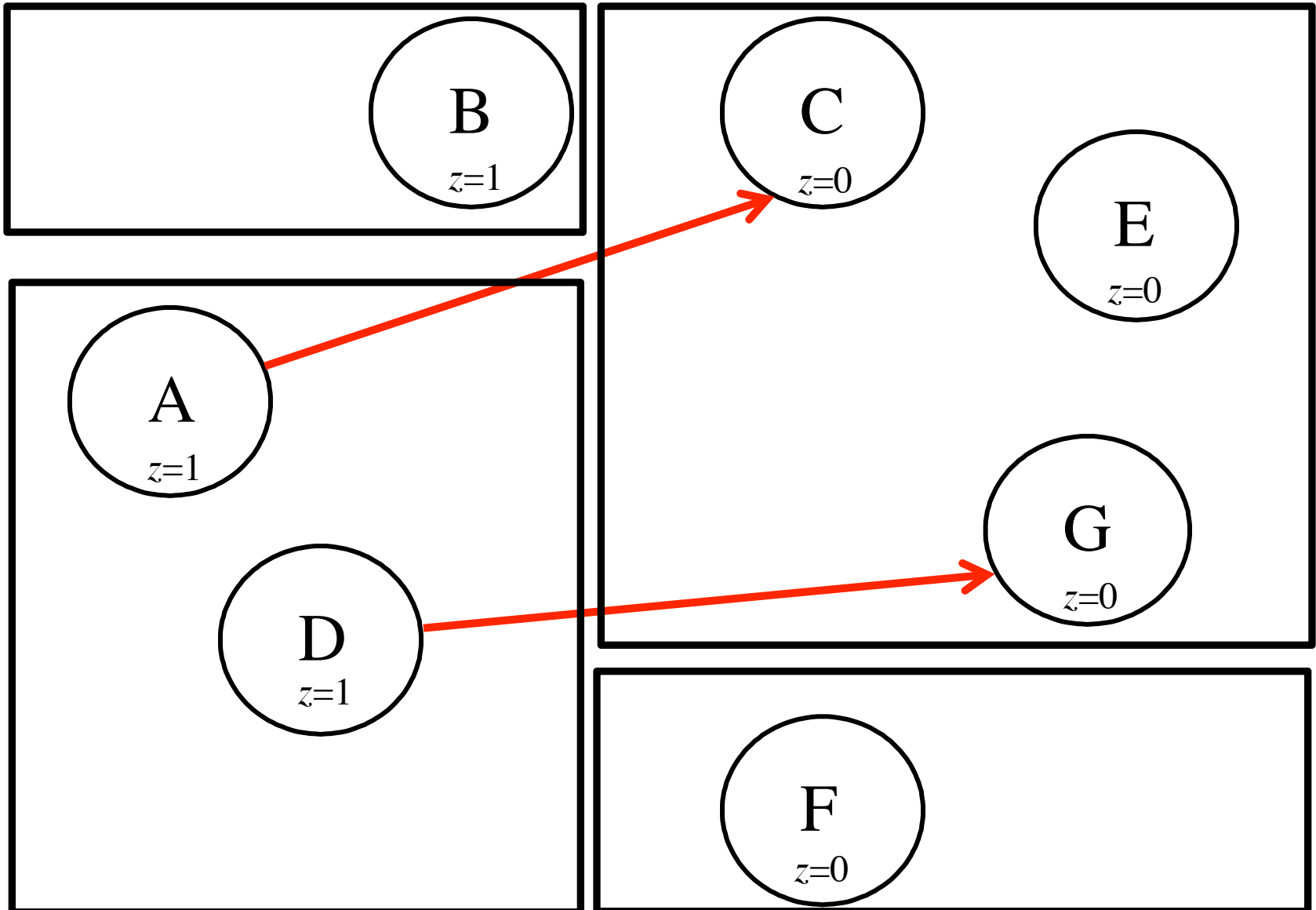

# Partition #5.2

(Examine the 0-successors of B)

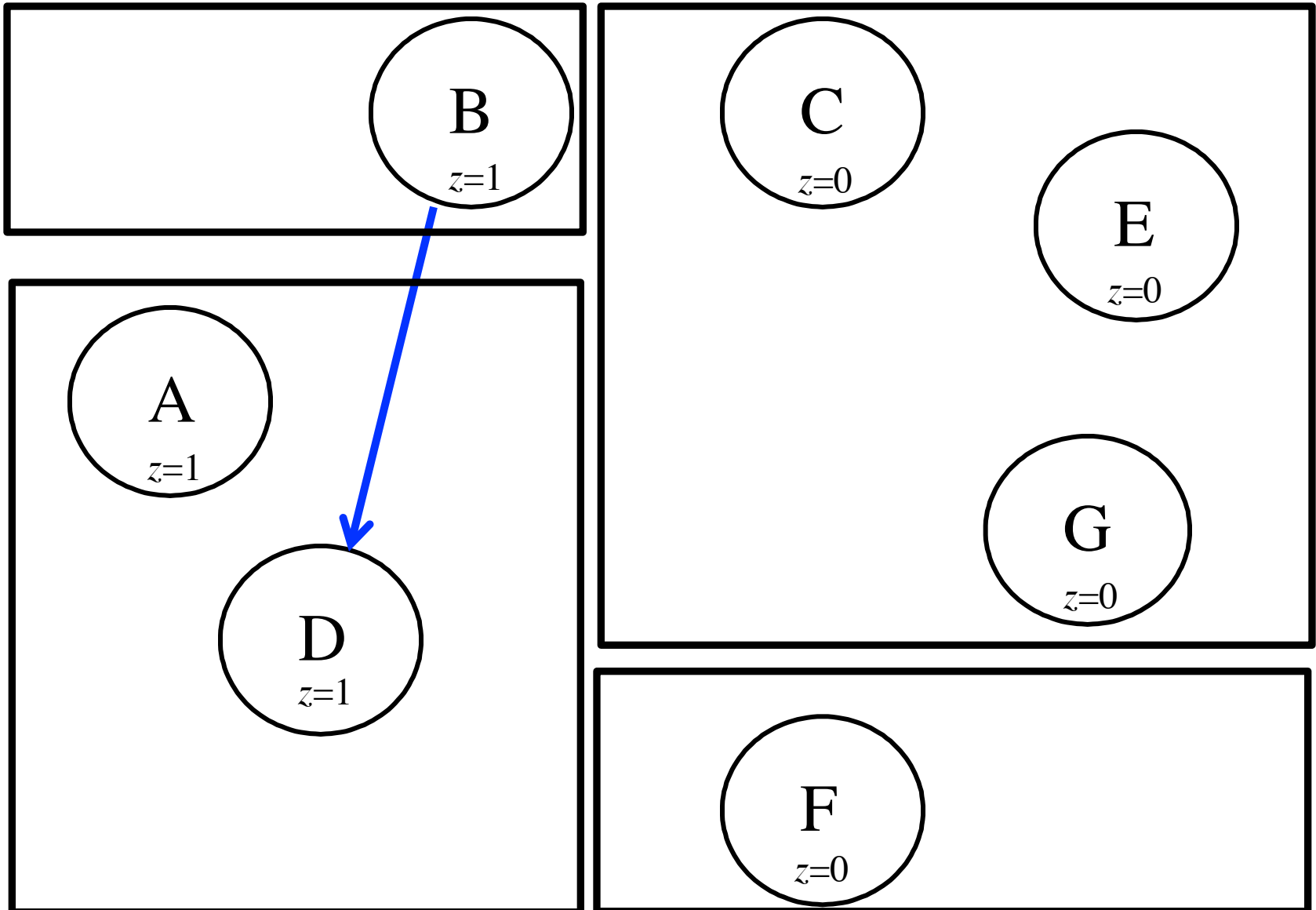

# Partition #5.2

(Examine the 1-successors of B)

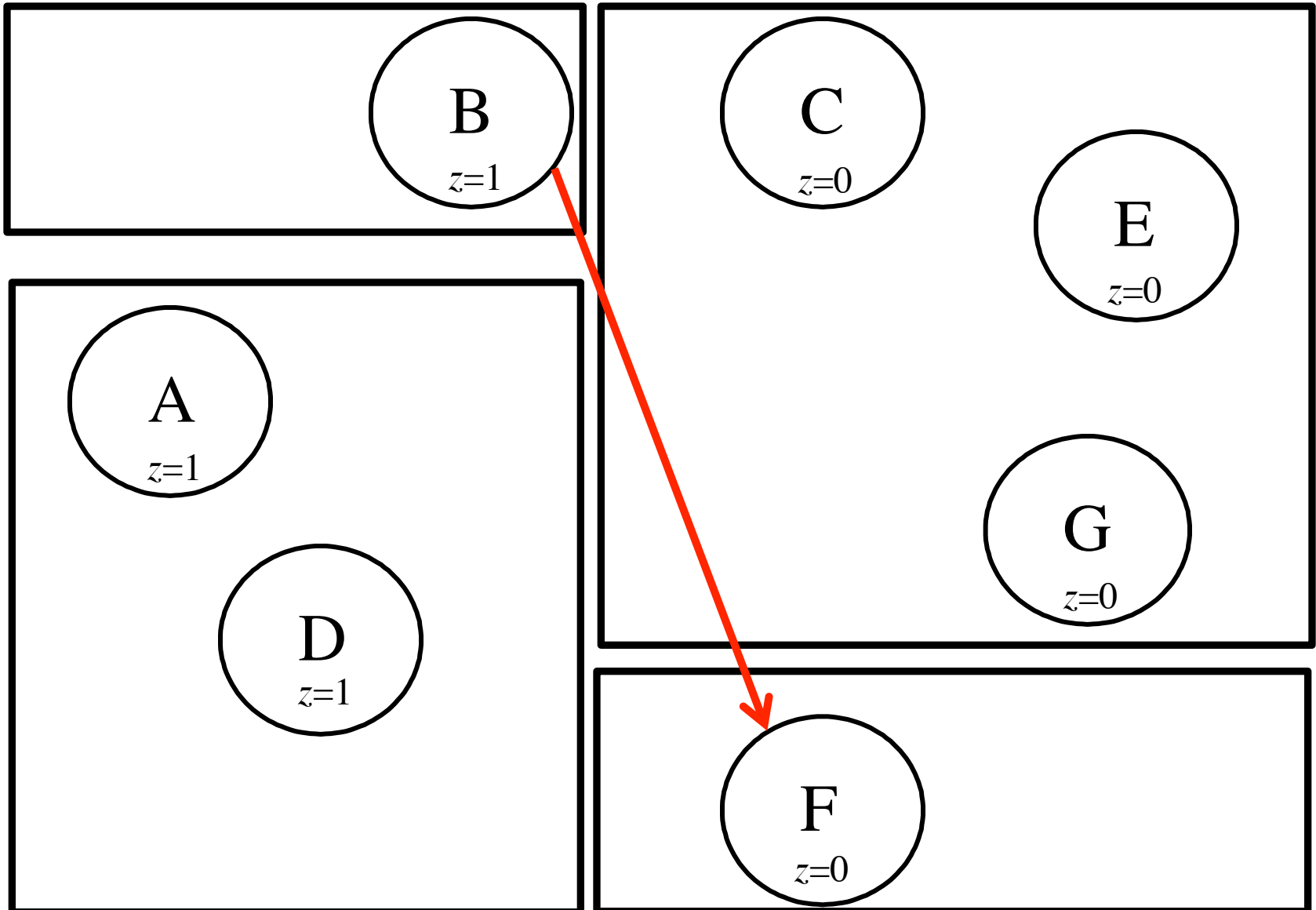

# Partition #5.3

(Examine the 0-successors of CEG)

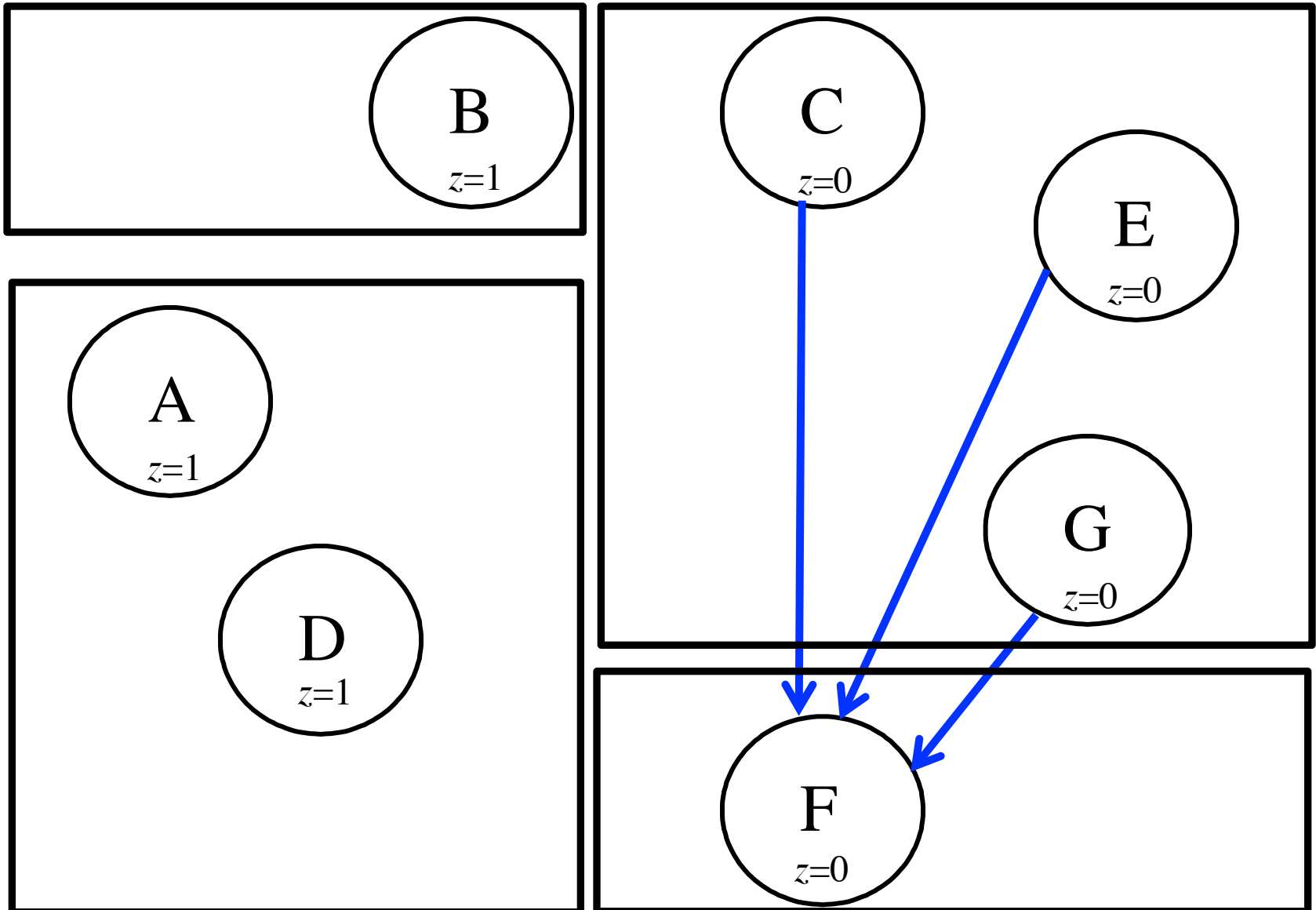

# Partition #5.3

(Examine the 1-successors of CEG)

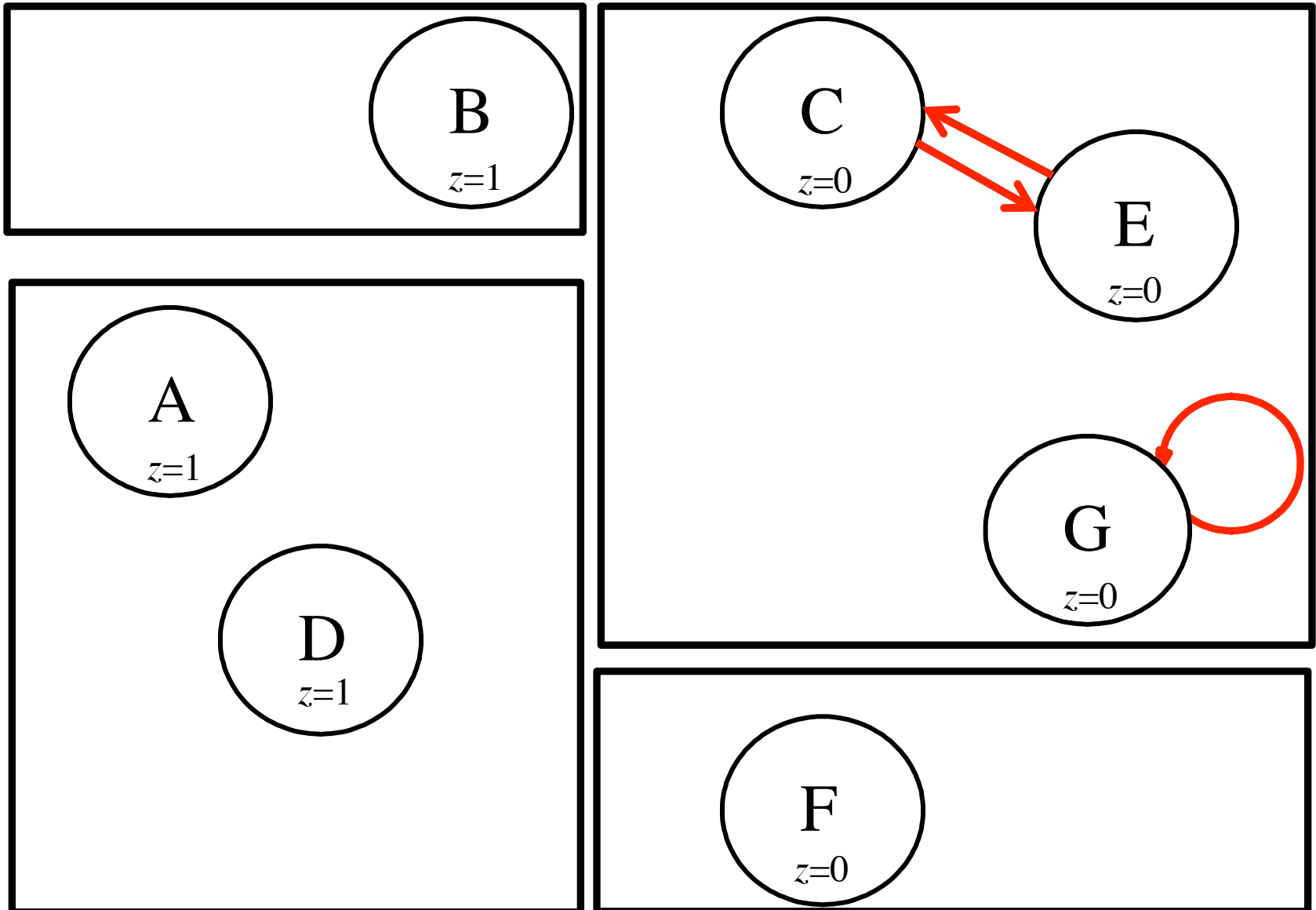

# Partition #5.4

(Examine the 0-successors of F)

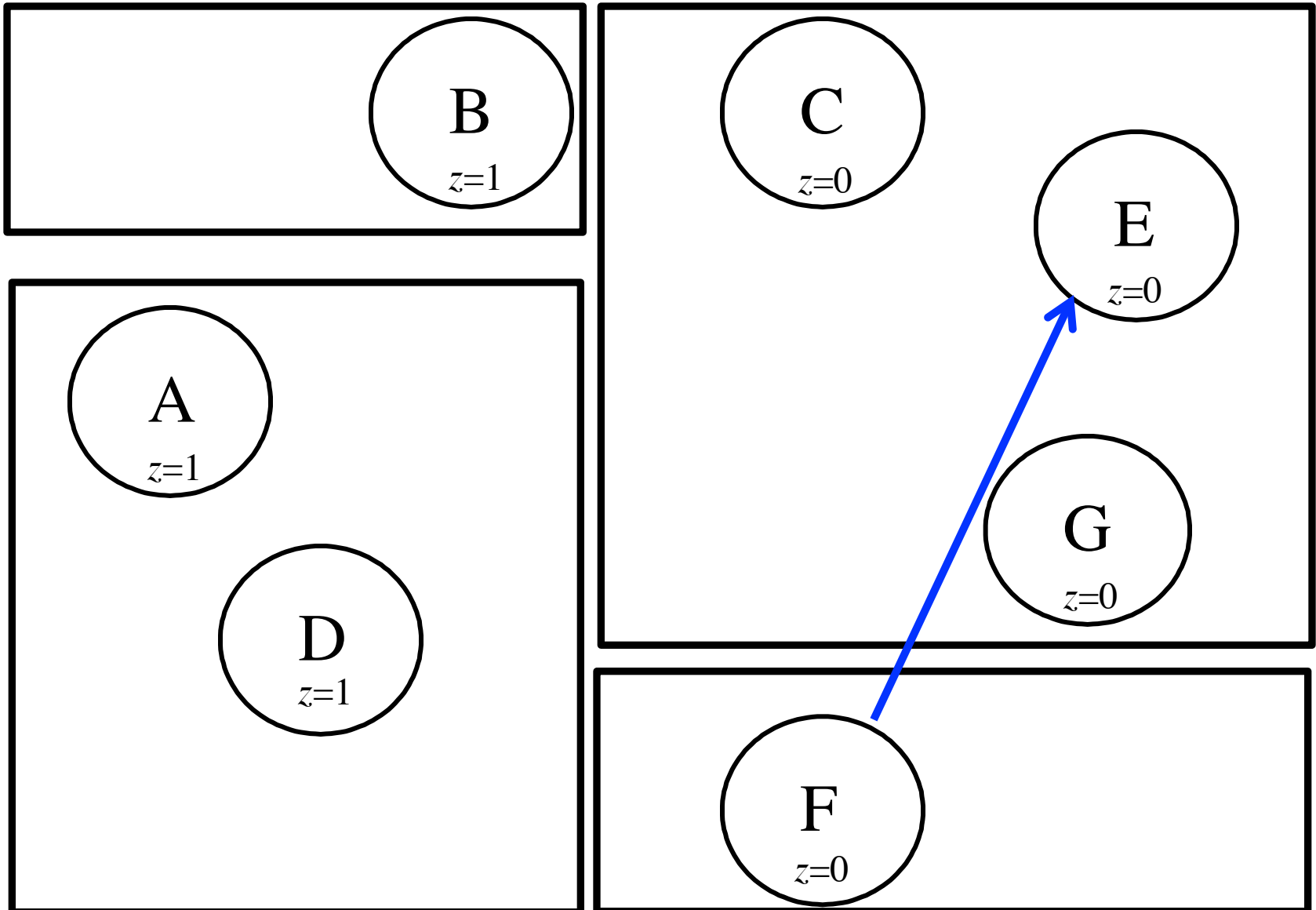

# Partition #5.4

(Examine the 1-successors of F)

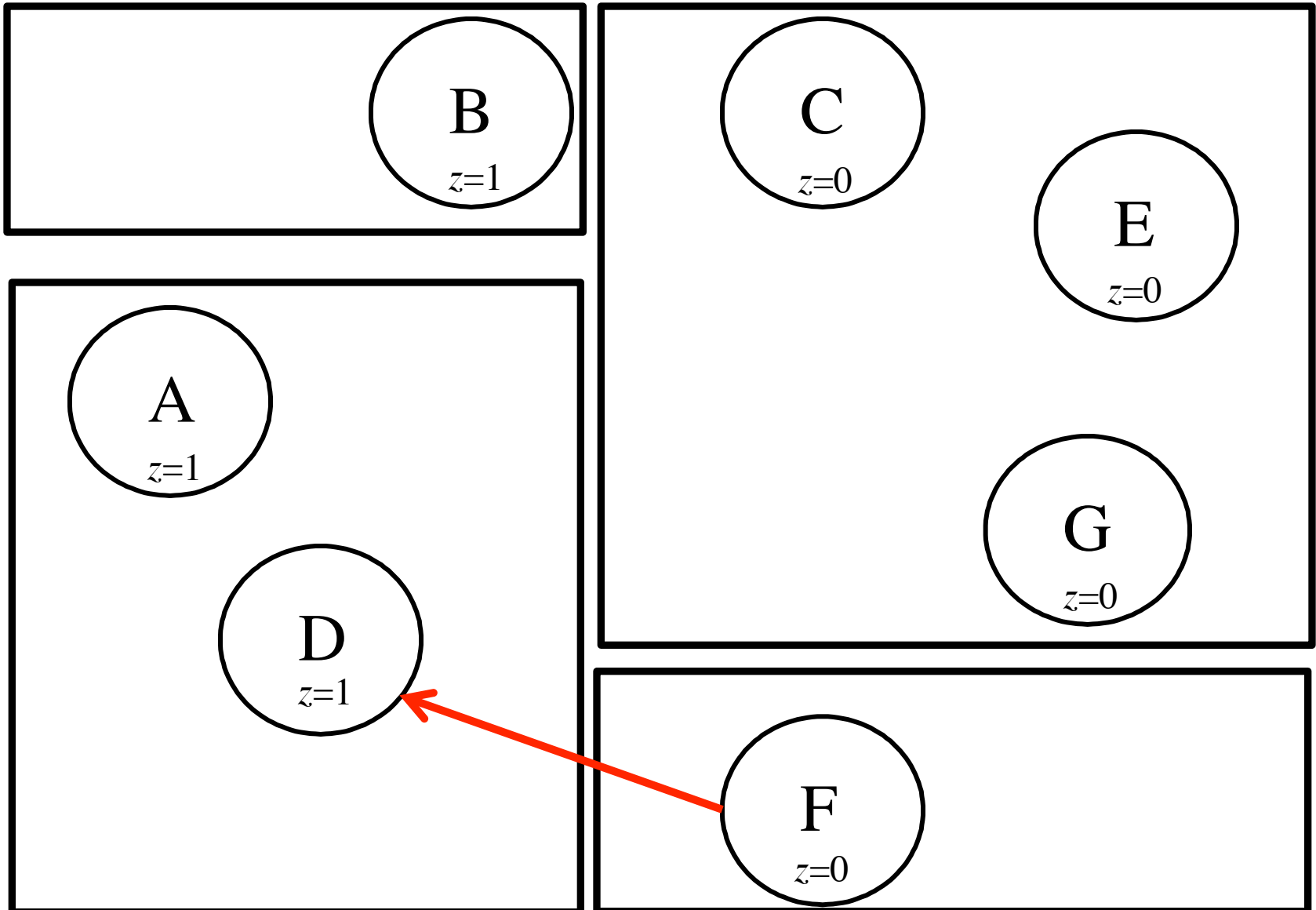

# Partition #5

(AD)(B)(CEG)(F)

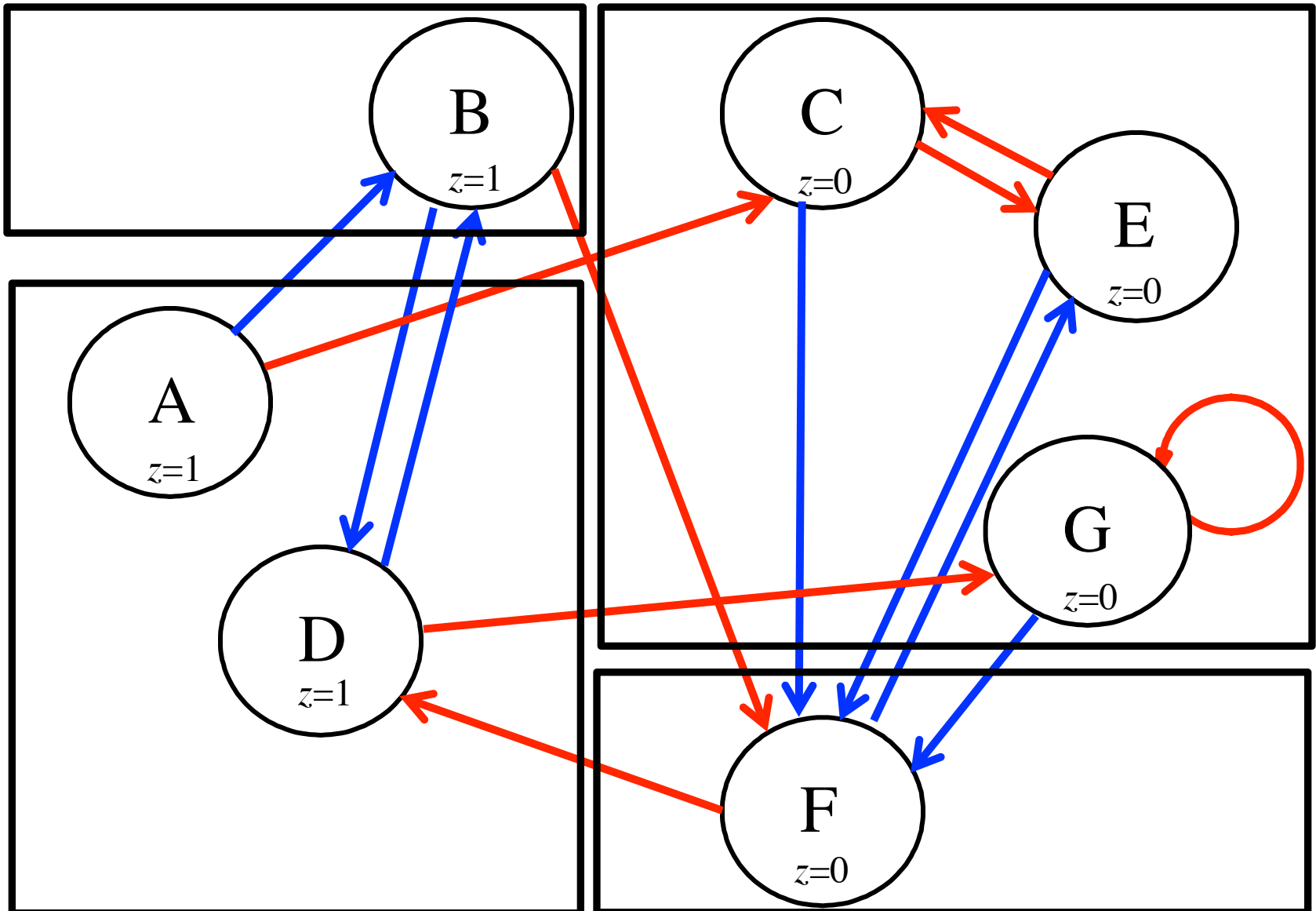



# Partition #4

(AD)(B)(CEG)(F)

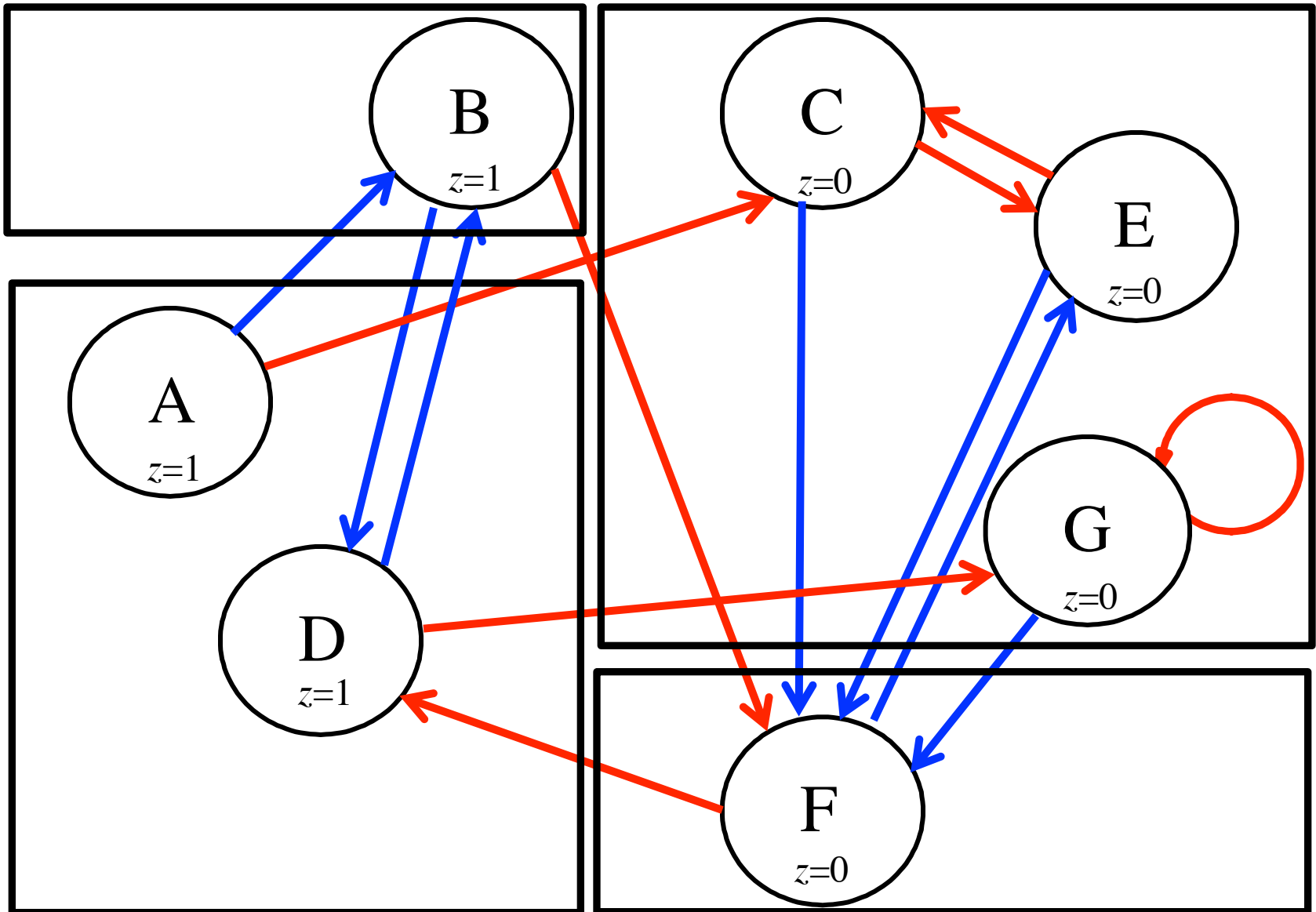

# Partition #5

(This is the same as #4 so we can stop here)

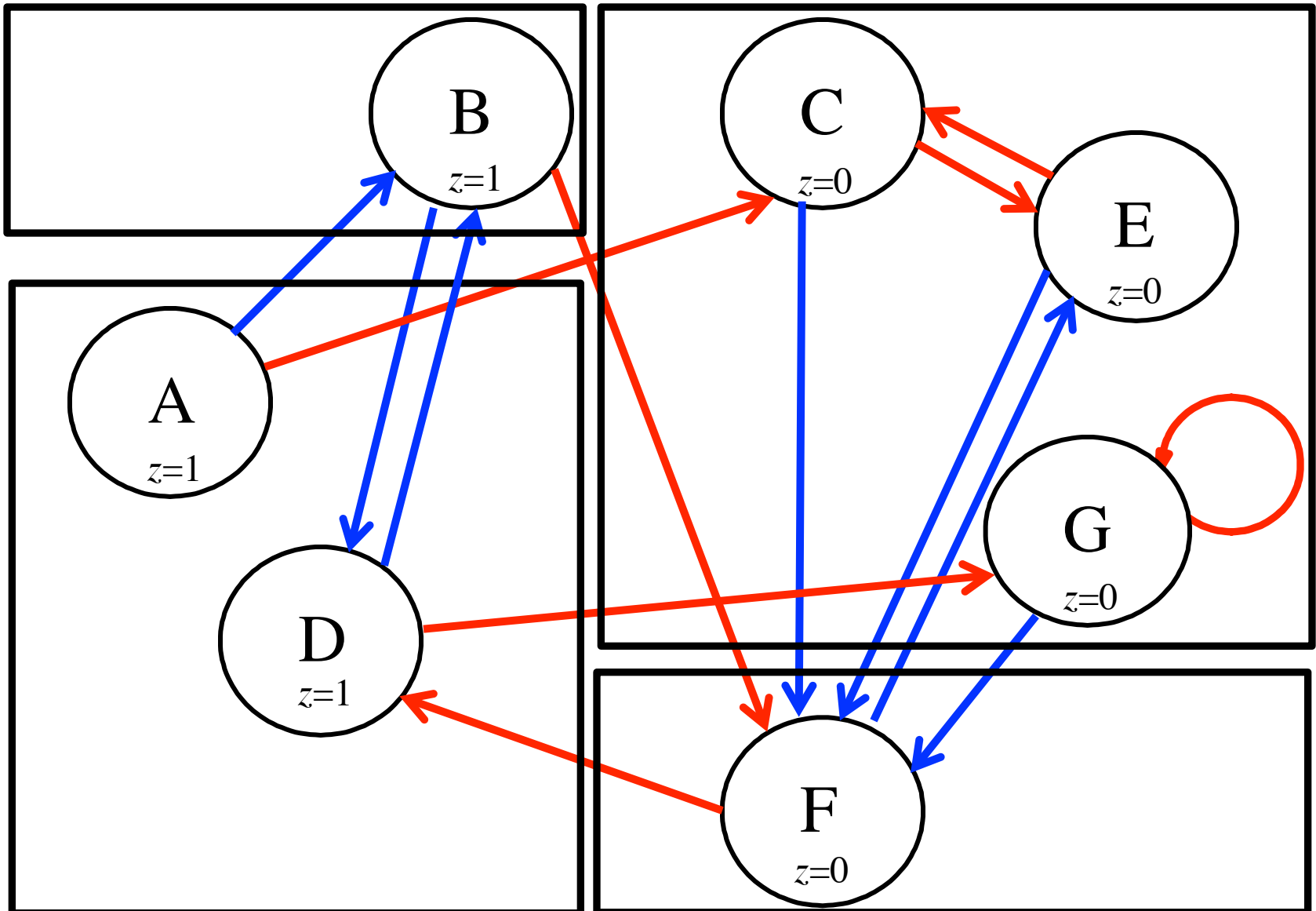

# Minimized state table

Present state	Nextstate		Output z
	w = 0	w = 1	
A	B	C	1
B	A	F	1
C	F	C	0
F	C	A	0

# **Vending Machine Example**

# Vending Machine Example

- The machine accepts nickels and dimes
- It takes 15 cents for a piece of candy to be released from the machine
- If 20 cents is deposited, the machine will not return the change, but it will credit the buyer with 5 cents and wait for the buyer to make a second purchase.

# Signals for the vending machine

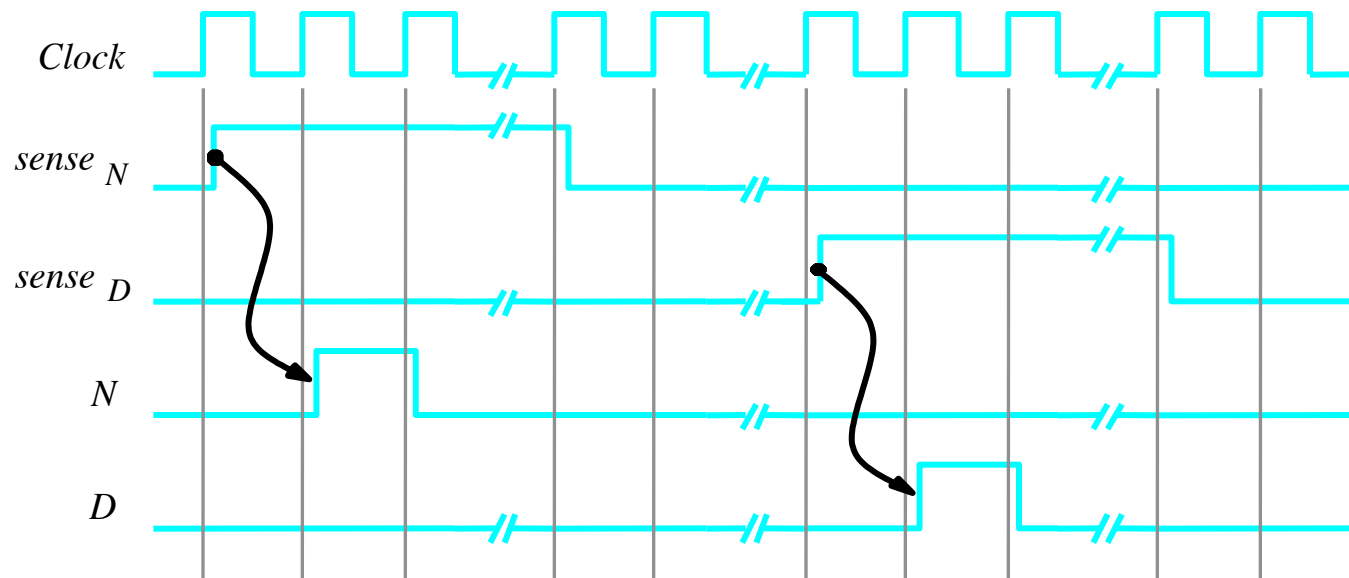

(a) Timing diagram

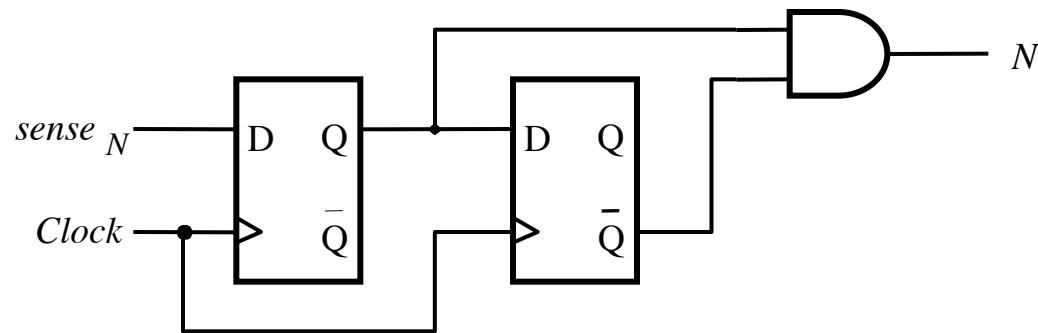

(b) Circuit that generates  $N$

[ Figure 6.53 from the textbook ]

# State Diagram for the vending machine

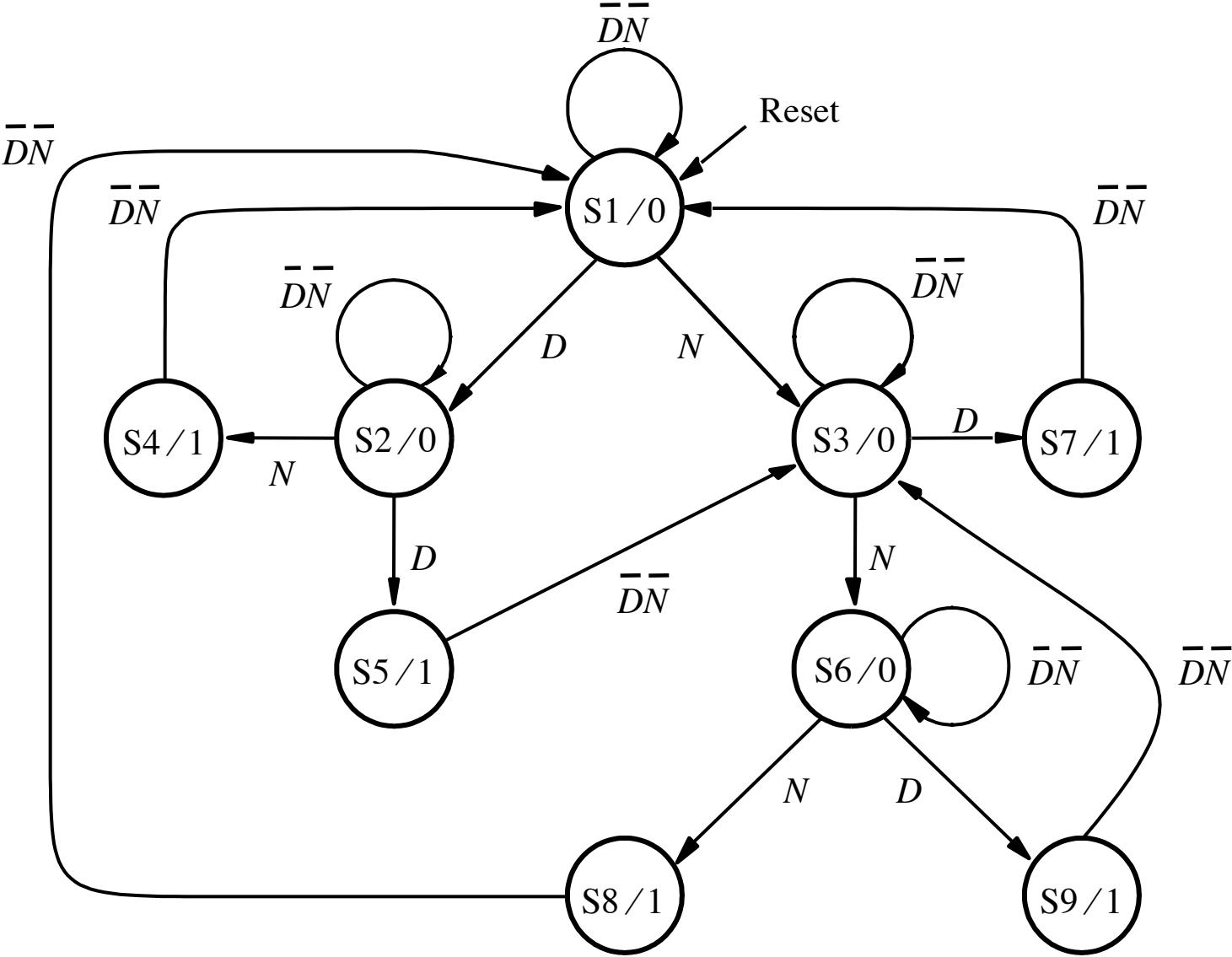

[ Figure 6.54 from the textbook ]

# State Diagram for the vending machine

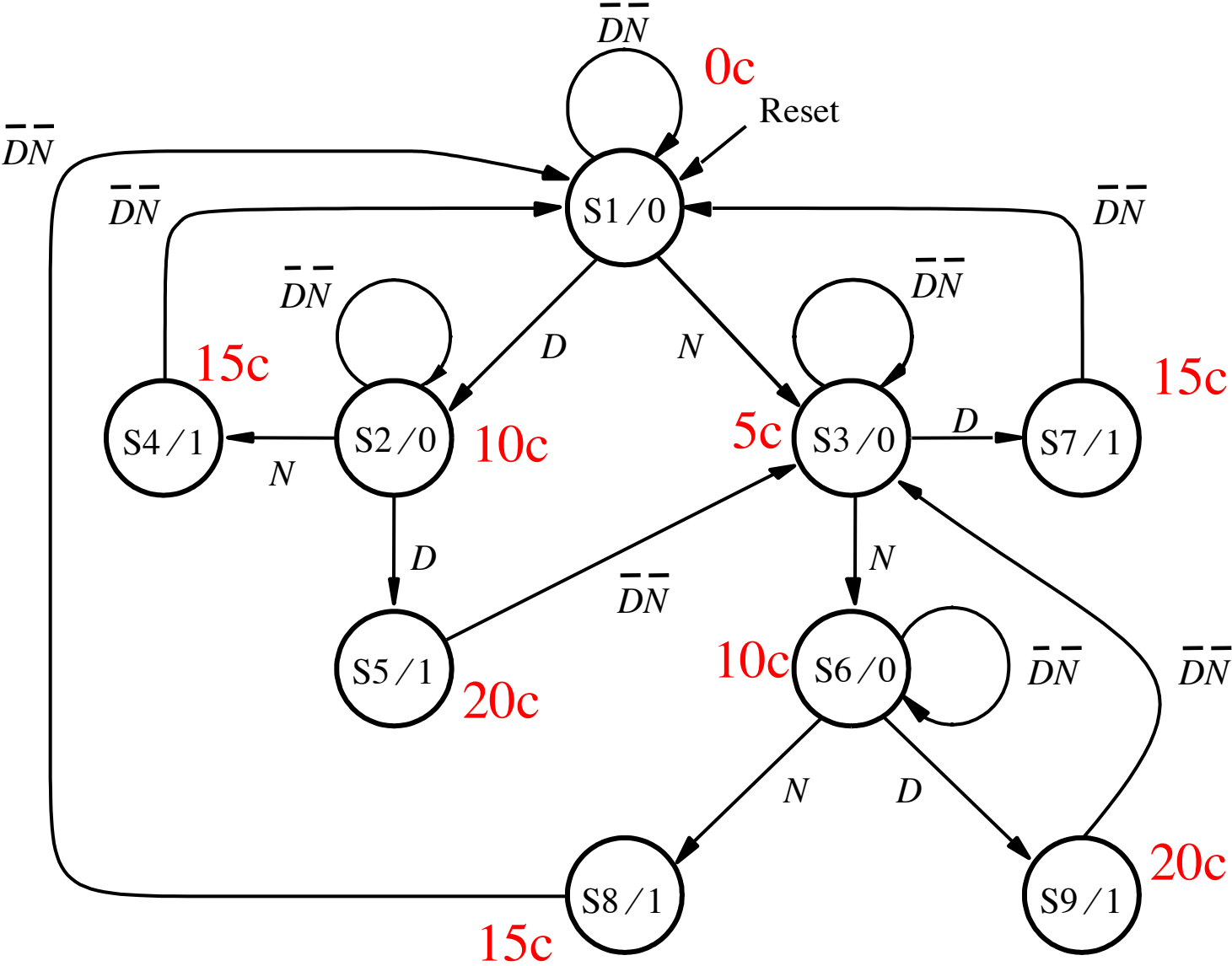

[ Figure 6.54 from the textbook ]



# State Table for the vending machine

Present state	Next state				Output $z$
	$DN$	$=00$	$01$	$10$	
S1	S1	S3	S2	–	0
S2	S2	S4	S5	–	0
S3	S3	S6	S7	–	0
S4	S1	–	–	–	1
S5	S3	–	–	–	1
S6	S6	S8	S9	–	0
S7	S1	–	–	–	1
S8	S1	–	–	–	1
S9	S3	–	–	–	1

Incompletely specified state table

# Partition for Vending Machine FSM

Present state	Next state				Output z
	00	01	10	11	
S1	S1	S3	S2	-	0
S3	S3	S6	S7	-	0
S2	S2	S4	S5	-	0
S6	S6	S8	S9	-	0
S4	S1	-	-	-	1
S7	S1	-	-	-	1
S8	S1	-	-	-	1
S5	S3	-	-	-	1
S9	S3	-	-	-	1

$P1=(S1,S2,S3,S4,S5,S6,S7,S8,S9)$

# Partition for Vending Machine FSM

Present state	Next state				Output z
	00	01	10	11	
S1	S1	S3	S2	-	0
S3	S3	S6	S7	-	0
S2	S2	S4	S5	-	0
S6	S6	S8	S9	-	0
S4	S1	-	-	-	1
S7	S1	-	-	-	1
S8	S1	-	-	-	1
S5	S3	-	-	-	1
S9	S3	-	-	-	1

P1=(S1,S2,S3,S4,S5,S6,S7,S8,S9)

P2=(S1,S2,S3,S6) (S4,S5,S7,S8,S9)

# Partition for Vending Machine FSM

Present state	Next state				Output z
	00	01	10	11	
S1	S1	S3	S2	-	0
S3	S3	S6	S7	-	0
S2	S2	S4	S5	-	0
S6	S6	S8	S9	-	0
S4	S1	-	-	-	1
S7	S1	-	-	-	1
S8	S1	-	-	-	1
S5	S3	-	-	-	1
S9	S3	-	-	-	1

P1=(S1,S2,S3,S4,S5,S6,S7,S8,S9)

P2=(S1,S2,S3,S6) (S4,S5,S7,S8,S9)

P3=(S1) (S3) (S2,S6) (S4,S5,S7,S8,S9)

# Partition for Vending Machine FSM

Present state	Next state				Output z
	00	01	10	11	
S1	S1	S3	S2	-	0
S3	S3	S6	S7	-	0
S2	S2	S4	S5	-	0
S6	S6	S8	S9	-	0
S4	S1	-	-	-	1
S7	S1	-	-	-	1
S8	S1	-	-	-	1
S5	S3	-	-	-	1
S9	S3	-	-	-	1

P1=(S1,S2,S3,S4,S5,S6,S7,S8,S9)

P2=(S1,S2,S3,S6) (S4,S5,S7,S8,S9)

P3=(S1) (S3) (S2,S6) (S4,S5,S7,S8,S9)

P4=(S1) (S3) (S2,S6) (S4,S7,S8) (S5,S9)

# Partition for Vending Machine FSM

Present state	Next state				Output z
	00	01	10	11	
S1	S1	S3	S2	-	0
S3	S3	S6	S7	-	0
S2	S2	S4	S5	-	0
S6	S6	S8	S9	-	0
S4	S1	-	-	-	1
S7	S1	-	-	-	1
S8	S1	-	-	-	1
S5	S3	-	-	-	1
S9	S3	-	-	-	1

P1=(S1,S2,S3,S4,S5,S6,S7,S8,S9)

P2=(S1,S2,S3,S6) (S4,S5,S7,S8,S9)

P3=(S1) (S3) (S2,S6) (S4,S5,S7,S8,S9)

P4=(S1) (S3) (S2,S6) (S4,S7,S8) (S5,S9)

P5=(S1) (S3) (S2,S6) (S4,S7,S8) (S5,S9)

# Partition for Vending Machine FSM

Present state	Next state				Output z
	00	01	10	11	
S1	S1	S3	S2	-	0
S3	S3	S6	S7	-	0
S2	S2	S4	S5	-	0
S6	S6	S8	S9	-	0
S4	S1	-	-	-	1
S7	S1	-	-	-	1
S8	S1	-	-	-	1
S5	S3	-	-	-	1
S9	S3	-	-	-	1

P1=(S1,S2,S3,S4,S5,S6,S7,S8,S9)

P2=(S1,S2,S3,S6) (S4,S5,S7,S8,S9)

P3=(S1) (S3) (S2,S6) (S4,S5,S7,S8,S9)

P4=(S1) (S3) (S2,S6) (S4,S7,S8) (S5,S9)

P5=(S1) (S3) (S2,S6) (S4,S7,S8) (S5,S9)

# Minimized State Table for the vending machine

Present state	Next state				Output $z$	
	$DN$	$=00$	$01$	$10$		$11$
S1		S1	S3	S2	—	0
S2		S2	S4	S5	—	0
S3		S3	S2	S4	—	0
S4		S1	—	—	—	1
S5		S3	—	—	—	1



# Minimized State Diagram for the vending machine

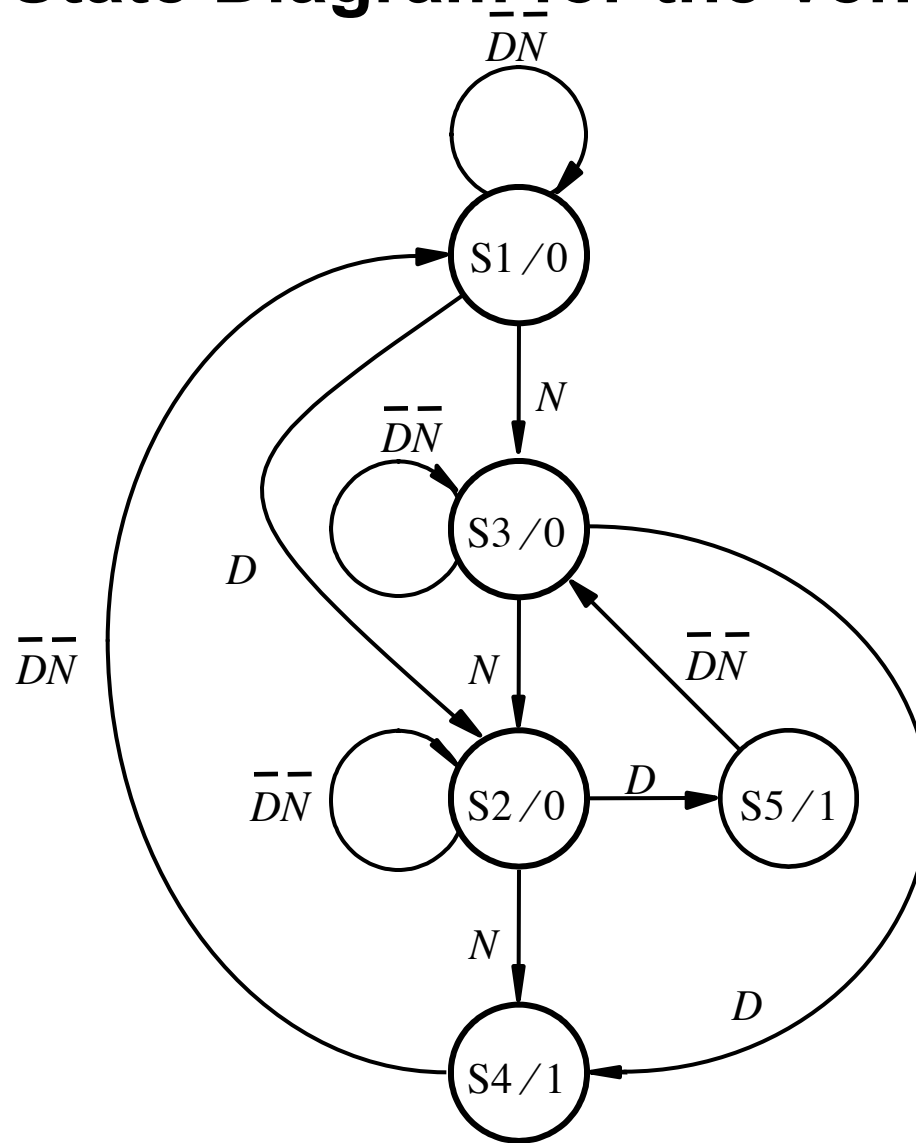

[ Figure 6.57 from the textbook ]

# Mealy-type FSM for the vending machine

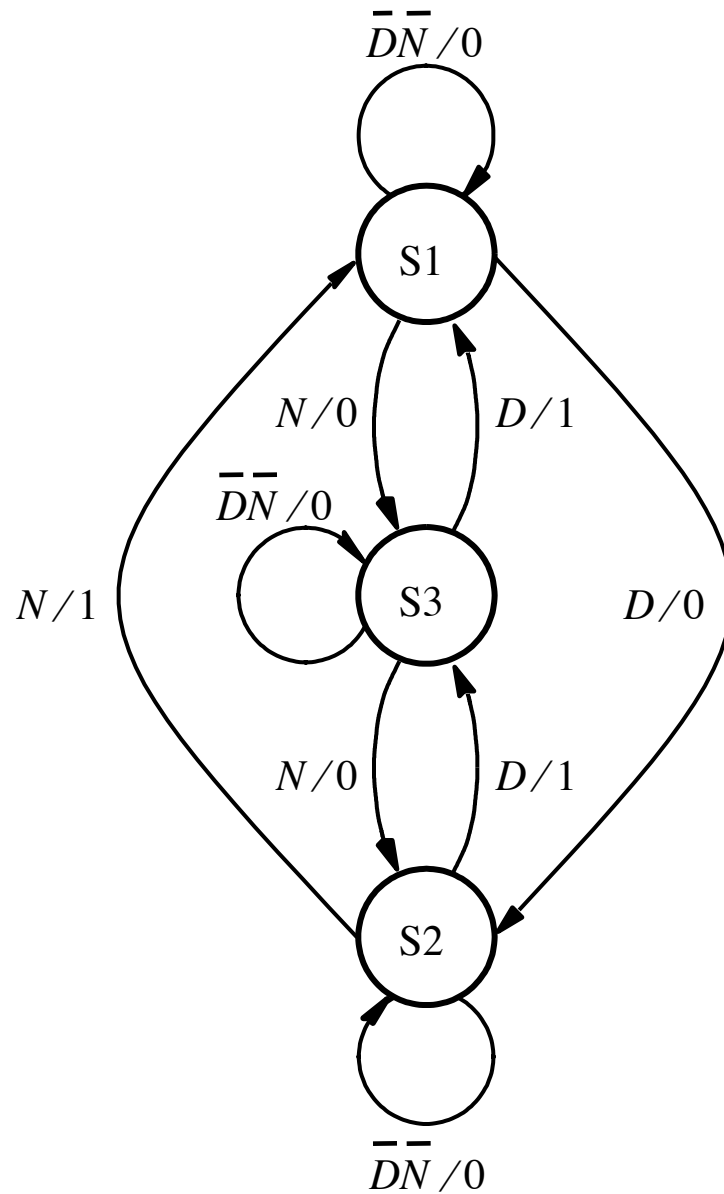

[ Figure 6.58 from the textbook ]



# Another Example of Incompletely specified state table

Present state	Next state		Output $z$	
	$w = 0$	$w = 1$	$w = 0$	$w = 1$
A	B	C	0	0
B	D	—	0	—
C	F	E	0	1
D	B	G	0	0
E	F	C	0	1
F	E	D	0	1
G	F	—	0	—

**Questions?**

**THE END**